

MAD USER MANUAL



MAD S3

S3-10.D2 / S3-12.D2

MADE TO PLAY LOUD

WE PLAY LOUD!!

We know what you want. You want it LOUD, and that is exactly what we do, what we live for. Vibrations, gut-punches and straight up loud music - that's what makes us tick. We won't dress up in fancy words or claim to be something we're not. We are the NO BULLSH!T car audio brand!











Every single product with the GAS logo on it is born out of passion, the same that has driven us for two generations and that will keep us rolling up to your neighbourhood, winning and pushing the limits for many generations to come!

It's up to you to choose your own level of loud, and if you don't like what we do that's OK. You are welcome back when you've had your first true GAS experience. We don't exclude, we don't judge and we do not make up any excuses for who we are.

We are GAS and we are proud to be LOUD!

GAS

TABLE OF CONTENT

 SAFETY.....	3
 UNPACKING.....	4
 DIMENSIONS.....	4
 SPECIFICATIONS.....	5
MAD S3-10.D2.....	5
MAD S3-12.D2.....	5
 PERFORMANCE.....	6
Thiele/Small parameters.....	6
Impedance vs frequency.....	6
 FEATURES.....	7
Light weight with heavy bass.....	7
Strong and flexible.....	7
Hardcore madness.....	7
Stay cool, stay loud.....	7
Ported perfection.....	7
 HOW TO.....	8
Install subwoofer.....	8
Build enclosure.....	9
Do I need polyfill?.....	10
 TROUBLESHOOTING.....	11
No power/sound.....	11
Unwanted noise.....	11
Distortion.....	11
 WARRANTY & DISPOSAL	12
 THE GAS WORLD.....	13



SAFETY

PLAY LOUD but play safe. Read through this information, follow the instructions and save the manual for future usage and reference.

Make sure to pay attention to the instructions when you see this symbol: 

Do not expose your new subwoofer to excessive damp or moisture. If the subwoofer is exposed it might result in electric failure, shock or damage to the product. Servicing is required when the product has been damaged in any way and/or doesn't operate normally. Refer all servicing to qualified service personnel only.

Keep the cables inside the vehicle separate from sharp edges or components that may be affected or take damage. Follow the recommended cable sizes and always use high quality cables and accessories. Even if you're eager to put the subwoofer to use - take no shortcuts when installing the cables, make sure that all connectors are protected and secured.

Do not drill any holes without checking what lies beneath, and don't cut anything without making sure that no important components risk being damaged.

There is a first time for everything, if you need help - ask a friend or contact your local GAS AUDIO POWER dealer/installer.

We want you to experience your product's MAD sound, but we don't want you to injure yourself or others. Use common sense, respect high pressure levels and volume, and follow your local laws and regulations.



UNPACKING

Unboxing your new MAD product is an experience, make sure that the subwoofer and all the accessories are included in the packaging:



Subwoofer
(1pc)

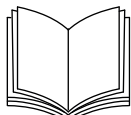

Manual
(1pc)

DIMENSIONS

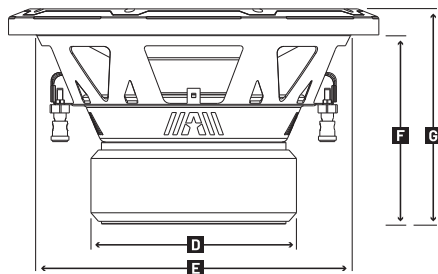
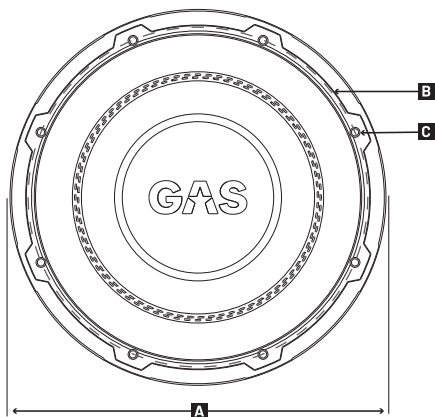

	A	B	C	D	E	F	G	
S3-10.D2	Ø271	Ø245	Ø5.2	Ø152	Ø231	135	155	mm
S3-12.D2	Ø325	Ø296	Ø5.2	Ø152	Ø280	142	162	mm

SPECIFICATIONS

Below you'll find the specifications that has been checked and tested in our workshop. The specified sensitivity isn't directly connected with the sound pressure in the vehicle, and shouldn't be used as the sole indicator for comparison with other subwoofers.

MAD S3-10.D2	
Component	Subwoofer
Size	10" (250mm)
Nominal impedance	2+2 Ohm
Power RMS	500W
Power MAX	1000W
Freq. response	22-200Hz
Voice coil	Dual 2" 4-layer copper wire
Voice coil former	TIL
Cone	Non-Pressed Paper
Dustcap	3D Aluminum
Basket	M Steel
Magnet	2x52oz HQ Ferrite
Suspension	Rubber with dual stitching
Spider	Nomex with Mesh
Tinsel	Silver coated leads
Terminal	Heavy duty push terminals
Weight	4.8 KG

MAD S3-12.D2	
Component	Subwoofer
Size	12" (300mm)
Nominal impedance	2+2 Ohm
Power RMS	600W
Power MAX	1200W
Freq. response	20-200Hz
Voice coil	Dual 2" 4-layer copper wire
Voice coil former	TIL
Cone	Non-Pressed Paper
Dustcap	3D Aluminum
Basket	M Steel
Magnet	2x52oz HQ Ferrite
Suspension	Rubber with dual stitching
Spider	Nomex with Mesh
Tinsel	Silver coated leads
Terminal	Heavy duty push terminals
Weight	5.7 KG



PERFORMANCE

THIELE/SMALL PARAMETERS

	S3-10.D2	S3-12.D2
Impedance	2+2 0hm	2+2 0hm
Re	3.6 0hm	3.6 0hm
Fs	29Hz	29Hz
Qms	3.75	3.93
Qes	0.33	0.39
Qts	0.31	0.35
Vas	38.3 L	62.6 L

	S3-10.D2	S3-12.D2
Sd	330.2cm ²	491.3cm ²
Mms	122.1g	158g
Le	2.703mH	2.712mH
Xmax	27mm	27mm
dB/SPL	86dB 1W/1M	88dB 1W/1M
BI	15.5	16.5
Driver Vol. Displacement	1.85 L	2.23 L

IMPEDANCE VS FREQUENCY

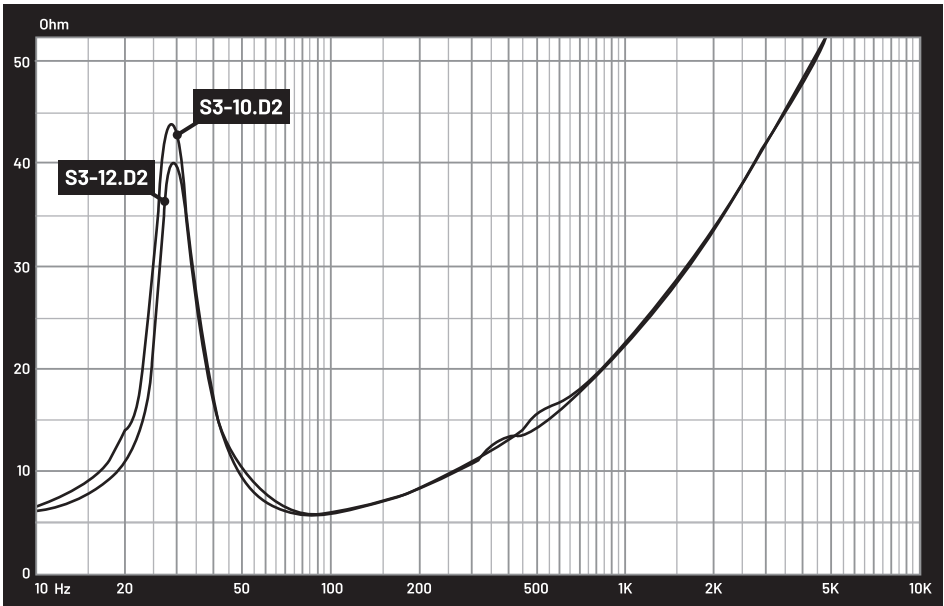

FEATURES

The MAD subwoofers are made to be LOUD and last for years to come. Those awesome vibrations are what drives us to create impressive subwoofers. We want to help you and your vehicle to be as LOUD as possible. We've made sure that is the case by using innovative and groundbreaking techniques that increase durability.

LIGHT WEIGHT WITH HEAVY BASS

The MAD S3-10.D2/S3-12.D2 subwoofer is a game changer! Similar to the awesome MAX S1/S2 series, this subwoofer has been loaded with a light-weight non-pressed paper cone and a 3D aluminum dust cap to hit hard, play LOUD and endure the toughest beats. The aluminum dust cap transfers away heat from the voice coils, and the embossed GAS logo minimizes resonances and ensures stability in every beat.

STRONG AND FLEXIBLE

Borrowing from the MAX S1/S2 series, we've equipped the MAD S3-10.D2/S3-12.D2 with a rubber suspension featuring dual-stitching. The suspension is strong, resilient and flexible to create a powerful sound that will shock and amaze! Of course, the dual-stitching comes in the iconic GAS orange that we all madly love.

HARDCORE MADNESS

The heart of the MAD S3 subwoofers is in the fully stacked core. First: Dual 2-0hm 2" TIL voice coils with 4-layer copper wire. This MAD setup creates allot of bass that's not only deep, but fast and hard hitting too! The voice coils are "non-conductive", which means they move smoothly through the magnetic gap without missing a beat.

Second: We have combined the MAD S1/S2 series robust steel M-basket with a double- stacked HQ ferrite motor from the MAX S1 series to create a real powerhouse! We've also included a robust pressure-bonded M-gasket in IMPP material that stabilizes the basket and minimizes the risk of damaging the suspension when securing the subwoofer.

STAY COOL, STAY LOUD

To make sure that the MAD S3 subwoofer stays cool, we have taken our popular DVST™ ventilation system to a new level. With the improved DVS2™ ventilation system (same technology that is used in the popular MAX S1 series) placed in both the subwoofer's backplate and in the basket under the spider, the MAD S3 series will keeps things cool even when the beats are scorching.

PORTED PERFECTION

To unleash the MADness of the MAD S3-10.D2/S3-12.D2 subwoofer, you need to mount it in an enclosure. Not just any type of enclosure - a ported enclosure! The subwoofers hardcore construction and powerful performance have been optimized for ported constructions. Your sound system will never be the same, and the definition of LOUD have been rewritten by the MAD S3 series.



HOW TO

INSTALL SUBWOOFER

Before installing your brand new subwoofer, make sure that you have everything you need. Have the right tools ready, and make sure that you have the necessary knowledge/skill to perform the installation properly. Preparation and knowledge is crucial!

The MAD S3-10.D2 and S3-12.D2 uses dual 2 ohm voice coils. If you want to connect two or more S2 series subwoofers, you can vary the impedance by altering the wiring configuration to use a series, parallel or series-parallel setup. The more the merrier!

Make sure to look through the recommended wiring schematics below and choose the setup that corresponds with the number of subwoofers in your sound system. Take note of the impedance stability of your amplifier. Don't be afraid to consult your local GAS AUDIO POWER dealer/installer if you have any questions.

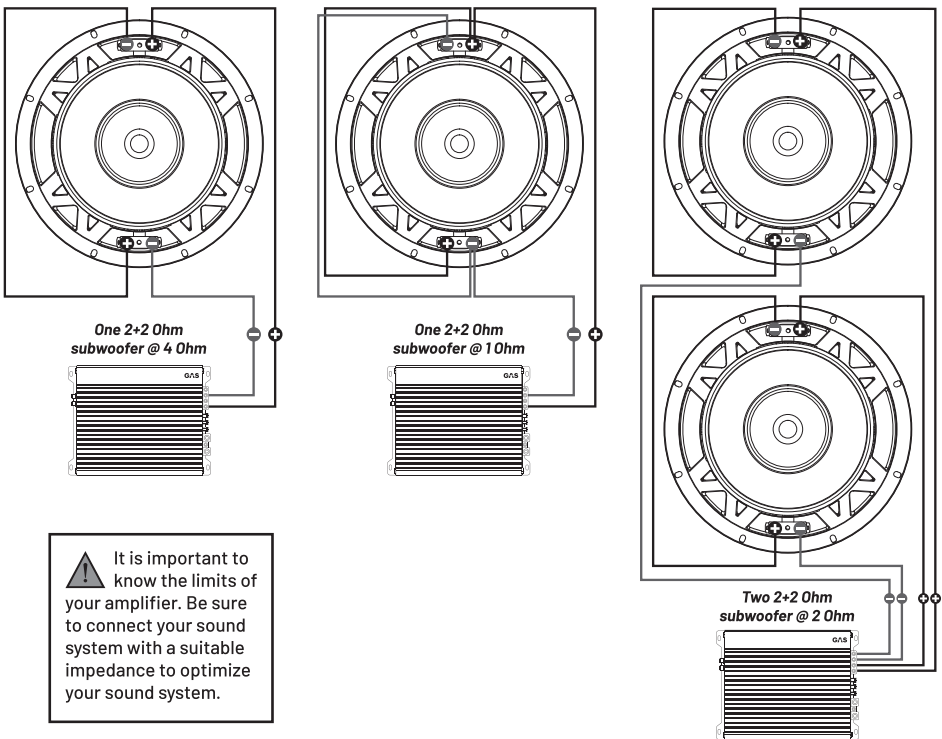

HOW TO

BUILD ENCLOSURE

If you want a LOUD and awesome looking sound system, you should mount your MAD subwoofer in an enclosure. Here's information about optimized volumes for different types of enclosures and how they perform with the MAD S3 subwoofer. If you feel unsure about how to build an enclosure on your own, consult a local GAS AUDIO POWER dealer/installer.

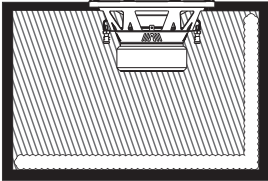

SEALED

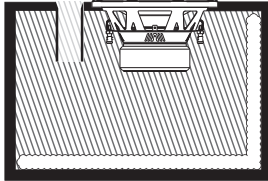

VENTED

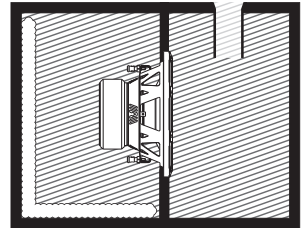

4TH ORDER BANDPASS

MAD S3-10D2:

	TOTAL VOLUME	FB	F3	PORT SIZE Ø	PORT LENGTH	POLYFILL
VENTED	24.06L*	42Hz	39.5Hz	1x3" (7.5cm)	27.2cm	Minimal
VENTED SPL	34.285L**	45Hz	39.3Hz	1x3" (7.5cm)	20.8cm	Minimal

* Total volume = Volume Net (21L) + Volume Driver (1.85L) + Volume Port (1.21L)

** Total volume = Volume Net (29L) + Volume Driver (1.85L) + Volume Port (3.435L)

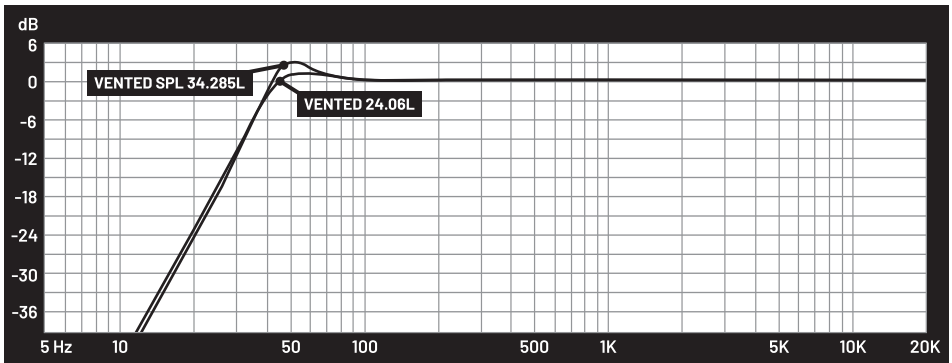

HOW TO

MAD S3-12D2:

	TOTAL VOLUME	FB	F3	PORT SIZE Ø	PORT LENGTH	POLYFILL
VENTED	37.87L *	42Hz	39.7Hz	1x4" (10.3cm)	38.3cm	Minimal
VENTED SPL	49.22L **	45Hz	38.9Hz	1x4" (10.3cm)	20.8cm	Minimal

* Total volume = Volume Net (32L) + Volume driver (2.27L) + Volume port (3.6L)

** Total volume = Volume Net (45L) + Volume driver (2.27L) + Volume port (1.95L)

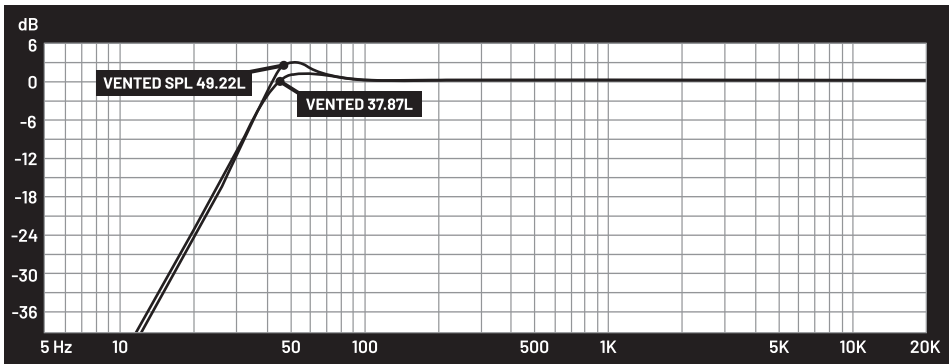

DO I NEED POLYFILL?

Hell yeah! We recommend using polyfill for all sealed, vented and bandpass enclosures for the best overall performance.

A polyfilled enclosure will bring out the full potential of your subwoofer, by starting an isothermal process when energy flows through the fibers (very scientific). This means that the air gets more dense, so it lessens the BOOM and brings out the BASS! It can also reduce harmonic distortion. Sounds complicated, we know. But it's easy to do! Cover two sides in a ported enclosure or make a loose polyfill ball behind the driver in a sealed enclosure. Try it out! If you like the bass to hit harder - just take away some. Do you want to lessen the effect? Put in some more.

TROUBLESHOOTING

NO POWER/SOUND

Check the subwoofer to make sure it isn't damaged. If your subwoofer doesn't get any power, the most common issue is either in the wiring or in the amplifier. Use a multimeter to measure the amplifier's voltage on the +12V terminal and the remote signal terminal. Use a multimeter to make sure that you have a negative ground connection. Check the built-in fuse (if there's one) on the amplifier. If there's no power coming through - control the fuse on the power cable. If this is intact - make a full check of the wiring to ensure cable integrity.

MAD S3-10D2/S3-12D2 is a dual voice coil subwoofer with dual connection terminals. Check the wiring of the coils. If several woofers and coils are wired in parallel the impedance will be too low for the connected amplifier to handle. This can make the amplifier go into protect mode with no sound as a result. Follow the wiring schematics on page 8.

Check all the speakers connected to your sound system. Check all the speaker cables and all the signal cables. Check your head unit to make sure no settings are limiting the amplifier's functions or the subwoofer. When all of the above has been tested/looked over, and all is as it should be but there's still no sound, consult your local GAS dealer.

UNWANTED NOISE

Start by looking over the subwoofer and other speakers in the sound system so there is no damage or connection issue with the wiring. Make sure that your signal cables or speaker cables aren't too close to the power cables. Check your amplifier's grounding point and make sure that the surface is clean. When all of the above has been tested/looked over, and the unwanted noise does not vanish, consult your local GAS dealer

DISTORTION

Start by looking over the subwoofer and other speakers in the sound system so there's no damage or connection issue with the wiring. Check the speaker cables to make sure that the polarity isn't reversed on one channel. Check the settings on the amplifier, make sure that the gain/level is set according to the amplifier's instructions. If your amplifier has a boost function, lower its effect or turn it off.



WARRANTY & DISPOSAL

This product is covered by warranty, depending on the conditions in the country where it's sold. If the subwoofer is returned for service, please include the original dated receipt (or a copy) with the product. Make sure that the subwoofer is packaged properly and secured, preferably in its original packaging.



The crossed-out wheeie bin symbol means that the product, literature and packaging included must be taken to separate collection at the end of their working life. Don't dispose of these products as unsorted municipal waste: take them for recycling. For info on your nearest recycling point, check with your local waste authority.



This product has been granted with the CE certification mark to show that the product follows the health, safety, and environmental protection standards for products sold within the European Economic Area (EEA).



GAS Audio Power products comply with the relevant provisions of the RoHS Directive for the European Union. In common with all Electrical and Electronic Equipment (EEE) the product shouldn't be disposed of as household waste. Alternative arrangements may apply in other jurisdictions.



GAS Audio Power is a global partner of the European Mobile Media Association, an organization that focus on promoting the custom made mobile media installations to consumers.

THE GAS WORLD

You've entered the world of GAS. We aim to please, and we've made sure to have products made for you. No matter what stage of the LOUD-addiction you might find yourself in, there is a GAS product to fill your need.

MAD

Just starting out? The MAD series is made to play LOUD and to be the express lane to a no bullsh!t sound system that will make sure everyone can hear you coming!

MAX

The MAX series holds products made to deserve the center stage. Powerful, heavy duty and designed to be noticed. We made NO COMPROMISES because we know that you wouldn't accept it.

CMP

The CMP series has been developed for the crucial seconds when the dB-counter starts to tick. All CMP products have hand-picked, high quality, COMPETITION GRADE components and they are specially designed to withstand an awesome amount of power.



THANKS FOR JOINING GAS AUDIO POWER!



GAS

AUDIO POWER

GAS AUDIO POWER and SHAKY are registered trademarks by Winn Scandinavia AB and is protected by relevant laws and jurisdictions such as Copyright and Trademark laws.

Winn Scandinavia AB | Elementvägen 15, 70227 Örebro, Sweden | www.winnscandinavia.com

Winn Scandinavia AB reserves for possible typos, factual or numeric errors that may have been printed on any products, package designs, user manuals and/or other included accessories.

GAS
AUDIO POWER