

KOBLINGSSKJEMA

Koblingskjema GAS MADB2-212 basskasse

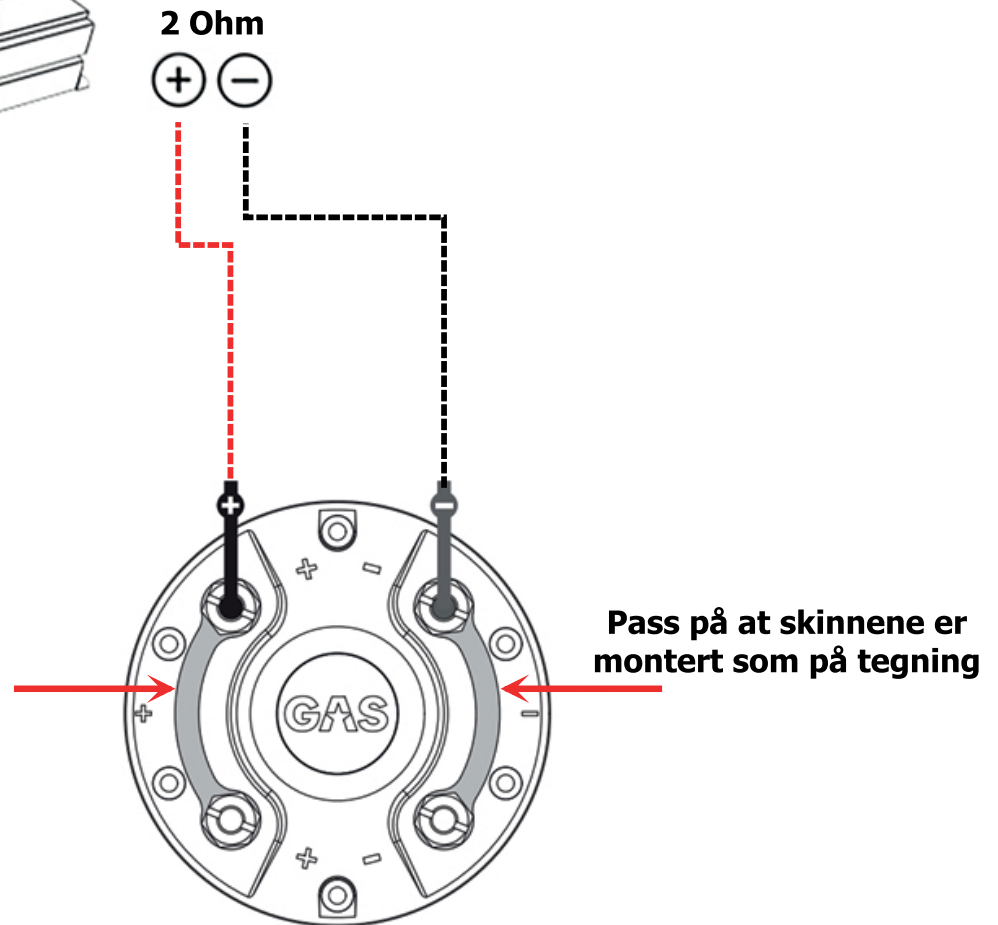
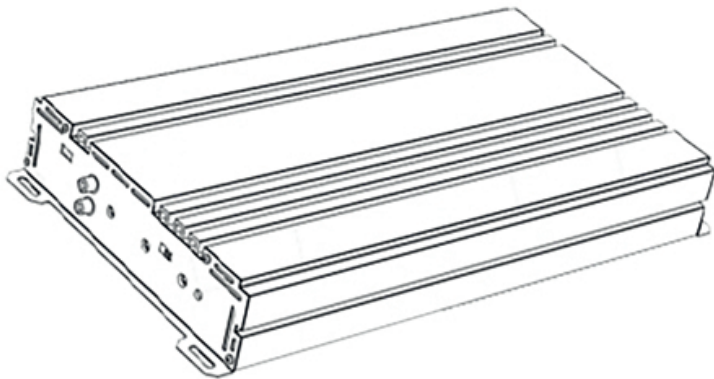

Forsterker bør IKKE monteres på basskasse p.g.a vibrasjoner

www.bassbrothers.no
