

SWEDISH • AUDIO • PASSION  
S

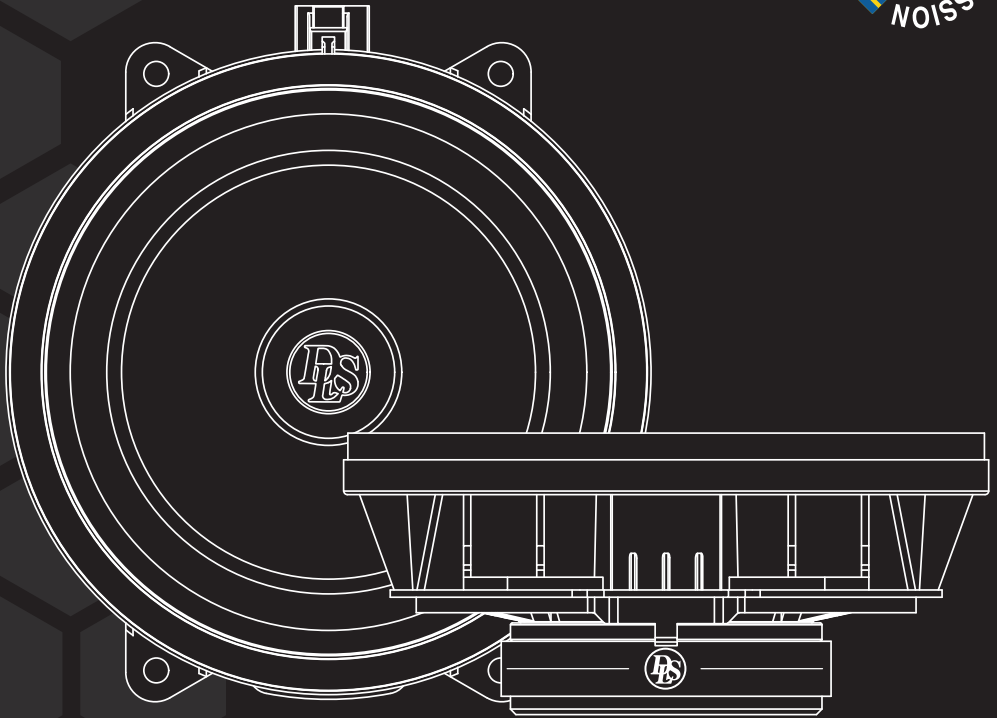

# CRPP-VO2.64/68

User manual

VOLVO



CRUISE



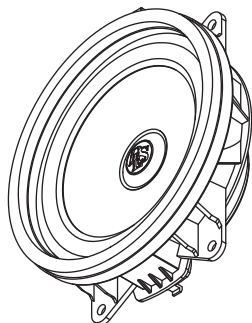

### Welcome to DLS!

Thank you for buying a DLS Cruise CRPP-VO2.64/68. For us, it's all about the sound experience. We care deeply about sound and construction quality. In order for your experience to be as optimal as possible, it is important that you read this manual, preferably before you start your installation. Keep the manual in a safe and accessible place for future reference.

Your speakers must be installed correctly in order to work as intended. Make sure you have all necessary tools nearby before starting and that you are completely confident in how to proceed. If you feel the slightest uncertainty, feel free to take the help of an experienced installer or a car audio dealer.

### Warranty

This speaker is covered by warranty, depending on the conditions in the country where it is sold. If the speaker is returned for service, please include the original dated receipt with the product.

### General

Some sound systems may vary in size of the installed speakers. Make sure that your vehicle has the same size as this speaker, before you start the assembly.

This is a generic mounting instruction. The approach is similar to all of the described car models. Some screws and clips may be placed differently depending on your car model.

### DECLARATION OF CONFORMITY

DLS Cruise speakers for vehicles are manufactured in accordance with the EU directive EEC 95/54 (72/245/ EEC) and are marked with the approval number. They are also marked in accordance with the WEEE-directive 2012/19/EC. The products are also produced in accordance with the EU RoHS directive 2015/863/EU.

# DLS CRUISE

## CRPP-VO2.64/68

### Content

|                                |    |
|--------------------------------|----|
| Welcome                        | 1  |
| Warranty                       | 1  |
| General                        | 1  |
| Declaration of conformity      | 1  |
| Included parts                 | 2  |
| Pre installation               | 2  |
| Mounting info                  | 2  |
| General door panel dismounting | 3  |
| Installation                   | 4  |
| Dismount door panel            | 4  |
| Change speakers                | 6  |
| Reassemble door panel          | 7  |
| Running-in time                | 8  |
| DLS support                    | 8  |
| Specifications                 | 9  |
| Impedance vs Frequency         | 9  |
| Dimensions                     | 10 |
| Compatible car models          | 11 |
| Product markings               | 12 |

DLS speakers are engineered by DLS Sweden,  
a part of:

**Winn Scandinavia AB**

Elementvägen 15 - SE-702 27 Örebro - Sweden

Tel: +46 19 20 67 65 - E-mail: info@dls.se

www.dls.se

**Designed & Sound tuned in Sweden.**



# Included parts

**Included products:**

2pcs Woofer speakers

**Included in box:**

4pcs Terminal crimp connectors

4pcs Adhesive foams for wrapping

2pcs Woofer adaptor cable bar ends (marked with WF)

1pc Pry tool

1pc Manual

# Pre installation

## *Disconnect Battery*

Before you start the process of replacing speakers, disconnect and secure the negative terminal from your battery/power source. This will prevent the risk of damaging yourself or the products.

Place the disconnected terminal in a secure and isolated location away from any possible connection belonging to the battery/power source system.

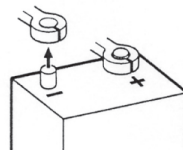

# Mounting info

Some sound systems may vary in size of the door speaker. Make sure that your vehicle has the same speaker size as this speaker, before you start the assembly

Bolts size can vary between 7 & 8 mm

Torx size can vary between T20 & T25



# General door panel dismounting

This is a generic mounting instruction. The approach is similar to all of the described car models. Some screws and clips may be placed differently and depending on your car model (see specific car models on the following page).

Remove the trim panel by using a PRY tool:



Remove the window control panel using PRY tool.  
Unplug the harness:



T20/T25 screw is located under the panel.  
Remove screw.



Remove the bolts using 7mm hex bit:



T20/T25 screw can be seen from under the arm rest, or there's a cover that needs to be removed.

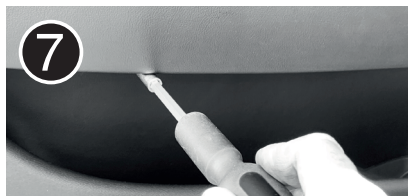

Finally. Move the door panel upwards to dismount.

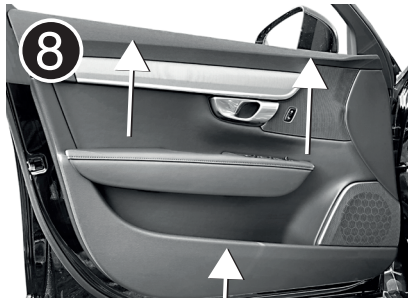



# Installation

## Dismount door panel

Dismount the door by removing the cover of the door panel.

**Hint:** Use plastic PRY tools to avoid marks on the panels or damaging the plastic clips.

### XC90



1) Remove the cover behind the door handle. Use PRY tool. Behind the cover are two T20/T25 screw. Unscrew them. Move the door panel upwards.

**Hint:** Sometimes it's easier to remove the window control panel and unplug the harness, before lifting up the door panel.

### S90/V90



### S90/V90

Remove the trim panel by using a PRY tool. Start at 1) and move towards 2).

Behind the trim panel are two 7mm bolts located. Remove screw.

3) Remove the window control panel using PRY tool. Unplug the harness. T20/T25 screw is located under the panel. Remove screw.

4) T20/T25 screw can be seen from under the arm rest, or there can be a cover that needs to be removed.

Move the door panel upwards.

**Remember:** Use the PRY tools to avoid marks on the panels or damaging the plastic clips.



### S60/V60



1) Remove the window control panel with PRY tool. Behind the control panel is one T25 screw located. Unscrew it. Unplug the harness. Start by removing the cover by the speakers. Use a PRY tool.

2) Start in the inside of the cover. Work your way towards the door handle.

3) Push the trim in the direction of the arrow. (There is a hook behind the trim)

Behind the trim is a 7mm bolt. Unscrew the bolt. Unplug the harness.

4) Under the arm rest is one T25 screw. Unscrew it. Move the door panel upwards.



## XC60



- 1) Remove the window control panel with PRY tool. Behind the control panel is one T20/T25 screw located. Unscrew it. Unplug the harness.
- 2) Under the arm rest is one T20/T25 screw. Remove the cover. Unscrew it.
- 3) At the bottom of the panel is a 7 or 8mm bolt. Unscrew it.  
Move the door panel upwards.

## XC40



- 1) At the bottom of the panel are two 7 or 8mm bolts. Unscrew them.
- 2) Under the arm rest are two T20/T25 screw. Unscrew them.
- 3) Behind the door handle is a rubber cover. Remove cover and under it is a 7 or 8mm bolt. Unscrew the bolt.  
Move the door panel upwards.

**Hint:** Sometimes it's easier to remove the window control panel and unplug the harness, before lifting up the door panel.

There are several electric and mechanical connectors on the backside of the door panel. Disconnect the cables to the door handle, speaker, window control and door light.

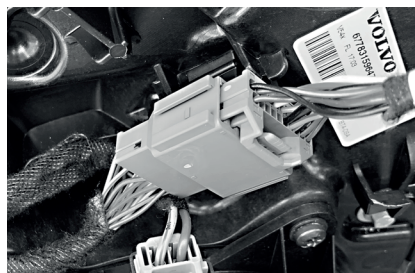
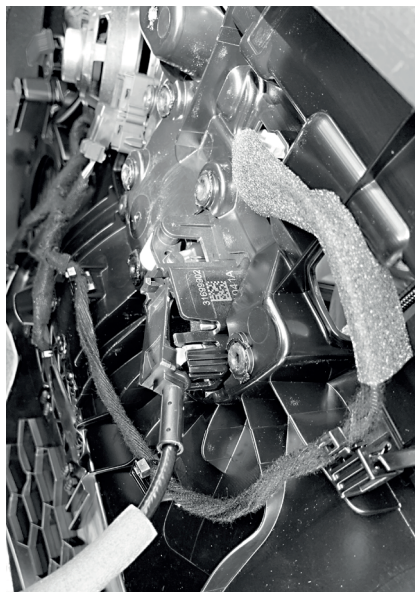





## Change speakers

Remove the woofer by unscrewing the T20 Torx. Unplug the speaker harnesses.

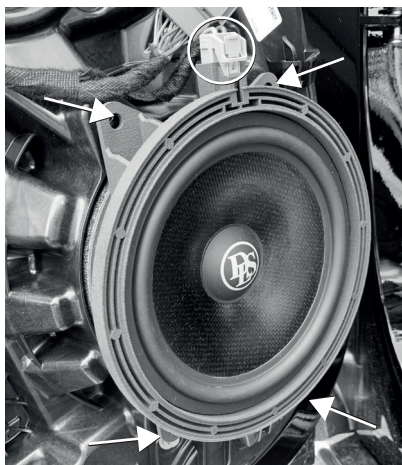
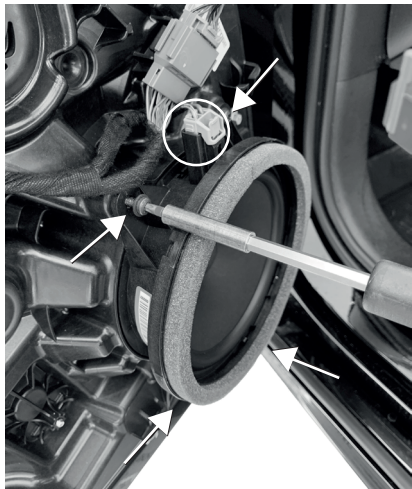

Use the OEM screws to fix the new DLS woofer. Make sure that the new DLS woofer is properly fixed and don't touch the surrounding plastic.

Plug in the new adaptor cable. The adaptor cable - WF, shall be used if original connector is cut.



Make sure to use adhesive foam pads to wrap the adaptor cables to avoid rattle from the door panel.

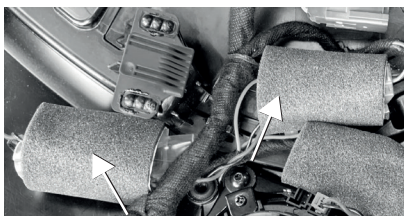

**HINT:** DLS recommends adding sound deadening material on the door panel before the assembling.





## Reassembly door



Connect all plugs to the door cover, reconnect the unlocking device, place the door cover from the top, by the window seal and push it gently down. Make sure the clips are in place and can engage. Give the door panel a push by the hand to attach to the clips. Mount and fasten all screws to the correct places. Make sure that no screws or clips are left over.

Reconnect the battery/power source terminal.

Now it's time to play some good music and enjoy!



## ***Running-in time***

Allow the speaker to play for at least 15-20 hours in order to perform at its possibly best. This run-in can be made with tone sweep or with just music.

Start at a moderate volume and increase the volume step by step during the running in period. After the 15-20 hour run in session the performance and characteristics will be in the correct condition.



## ***DLS Support***

For technical assistance, ask your car audio dealer where the product was sold or the distributor in your country. You can always contact the DLS Help desk in Sweden at e-mail: [info@dls.se](mailto:info@dls.se). Information can also be found on our WEB- site [www.dls.se](http://www.dls.se). We follow a policy of continuous advancement in development. For this reason, all or part of the specifications and designs may be changed without prior notice.



# Specifications

|                                    |                                    |                                    |                                    |
|------------------------------------|------------------------------------|------------------------------------|------------------------------------|
| <b>Art. no</b>                     | <b>CD-CRPP-VO2.64</b>              | <b>Art. no</b>                     | <b>CD-CRPP-VO2.68</b>              |
| Woofers                            | 6.5" / 165mm with glass fibre cone | Woofers                            | 6.5" / 165mm with glass fibre cone |
| RMS Power                          | 100W                               | RMS Power                          | 100W                               |
| MAX Power                          | 200W                               | MAX Power                          | 200W                               |
| Impedance                          | 4 Ohm                              | Impedance                          | 8 Ohm                              |
| Sensitivity                        | 86dB 1W/1M                         | Sensitivity                        | 87.7dB 1W/1M                       |
| Freq. range                        | 55 - 5000Hz                        | Freq. range                        | 55 - 5000Hz                        |
| <b>Technical specifications</b>    |                                    | <b>Technical specifications</b>    |                                    |
| Voice Coil Material                | CCA W voice coil/ Kapton former    | Voice Coil Material                | CCA W voice coil/ Kapton former    |
| Basket                             | Glass Fibre Reinforced ABS         | Basket                             | Glass Fibre Reinforced ABS         |
| Magnet                             | Ferrite                            | Magnet                             | Ferrite                            |
| Cone                               | Glass fibre                        | Cone                               | Glass fibre                        |
| Suspension                         | Rubber                             | Suspension                         | Rubber                             |
| <b>Electro-Acoustic Parameters</b> |                                    | <b>Electro-Acoustic Parameters</b> |                                    |
| Re                                 | 3.2 Ohm                            | Re                                 | 7.2 Ohm                            |
| Fs                                 | 60.4Hz                             | Fs                                 | 59.1Hz                             |
| Mms                                | 14.1gr                             | Mms                                | 15.4gr                             |
| Cms                                | 0.492                              | Cms                                | 0.471                              |
| Vas                                | 13.48L                             | Vas                                | 12.91L                             |
| Qts                                | 0.87                               | Qts                                | 0.62                               |
| Qes                                | 1.15                               | Qes                                | 0.69                               |
| Qms                                | 3.71                               | Qms                                | 6.132                              |
| Bl                                 | 3.86T.m                            | Bl                                 | 7.71T.m                            |
| Spl                                | 86dB 1W/1M                         | Spl                                | 87.7dB 1W/1M                       |
| Sd                                 | 139cm <sup>2</sup>                 | Sd                                 | 139cm <sup>2</sup>                 |

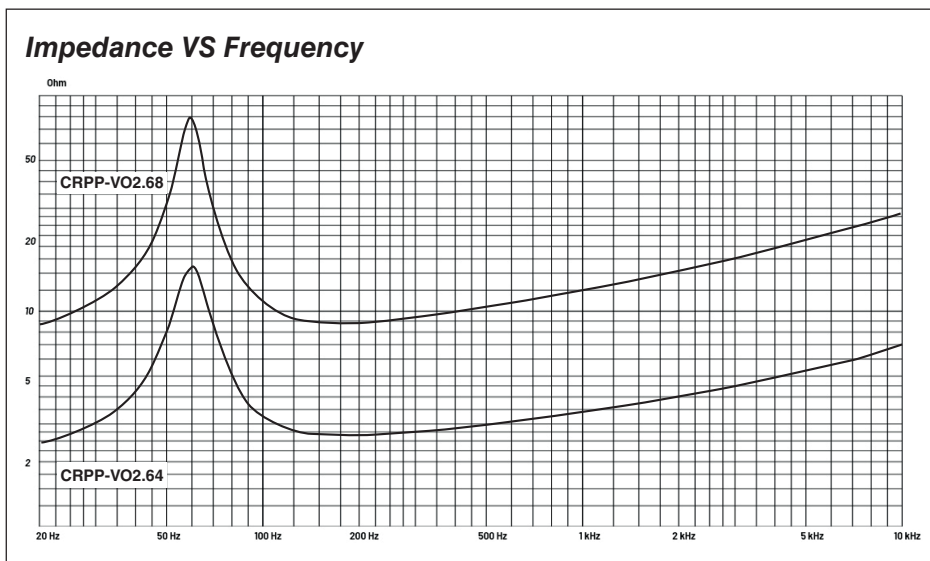



## Dimensions

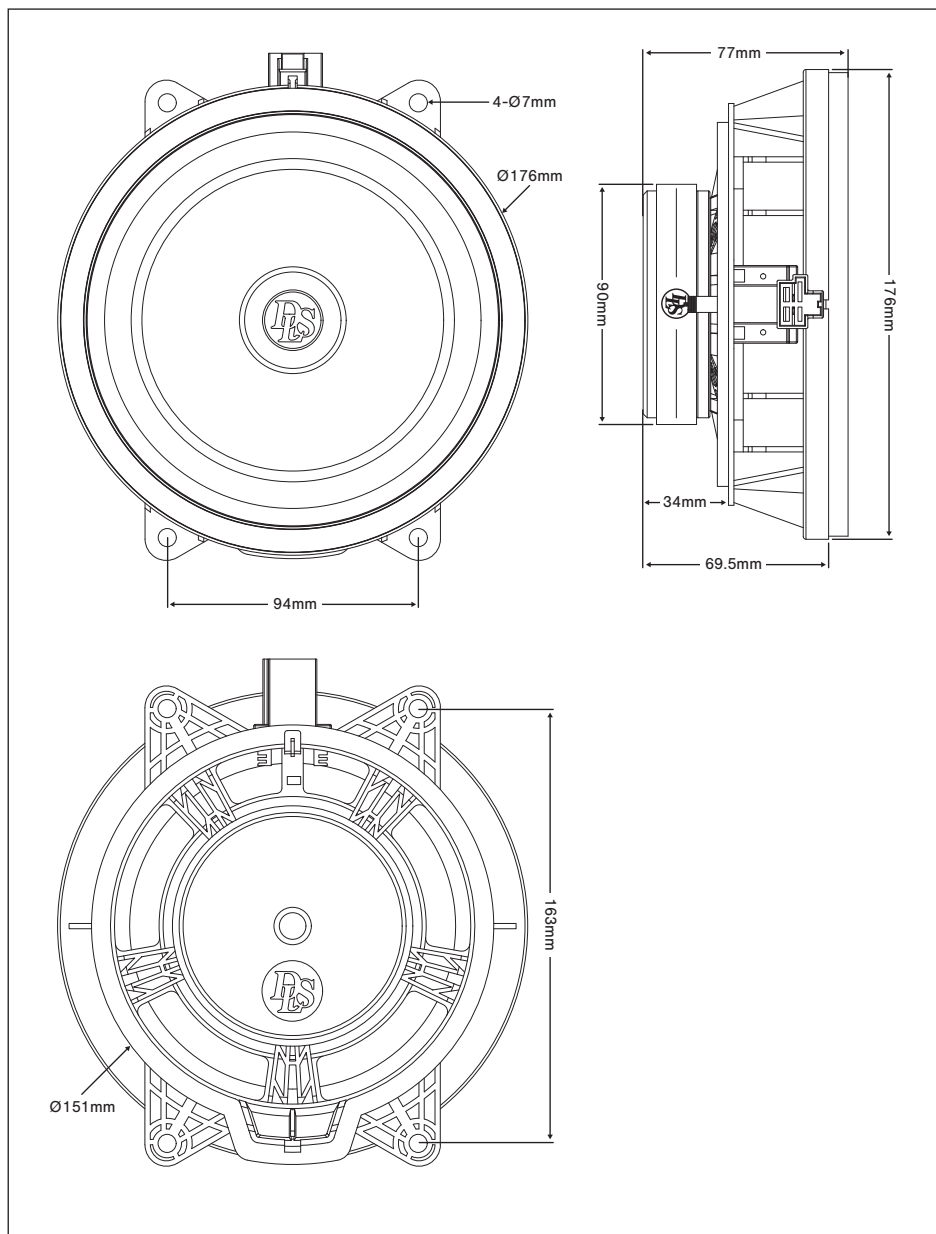



# Compatible car models

The DLS Cruise CRPP-VO2.64 & CRPP VO2.68 woofer speakers are developed to be installed in the front door of Volvo car models.

## ***DLS Cruise CRPP-VO2.64 compatible car models***

| <b>Car</b> | <b>Model</b> | <b>Year</b>  | <b>Front speaker</b> | <b>Rear speaker</b> |
|------------|--------------|--------------|----------------------|---------------------|
| Volvo      | S60/V60      | 2018-Present | CRPP-VO2.64*         |                     |
| Volvo      | S90/V90      | 2016-Present | CRPP-VO2.64*         |                     |
| Volvo      | XC40         | 2017-Present | CRPP-VO2.64*         |                     |
| Volvo      | XC60         | 2017-Present | CRPP-VO2.64*         |                     |
| Volvo      | XC90         | 2014-Present | CRPP-VO2.64*         |                     |

\*Disclaimer

Only compatible with Harman/Kardon and B&W sound system.

## ***DLS Cruise CRPP-VO2.68 compatible car models***

| <b>Car</b> | <b>Model</b> | <b>Year</b>  | <b>Front speaker</b> | <b>Rear speaker</b> |
|------------|--------------|--------------|----------------------|---------------------|
| Volvo      | S60/V60      | 2018-Present | CRPP-VO2.68**        |                     |
| Volvo      | S90/V90      | 2016-Present | CRPP-VO2.68**        |                     |
| Volvo      | XC40         | 2017-Present | CRPP-VO2.68**        |                     |
| Volvo      | XC60         | 2017-Present | CRPP-VO2.68**        |                     |
| Volvo      | XC90         | 2014-Present | CRPP-VO2.68**        |                     |

\*\*Disclaimer

Only compatible with Performance and High Performance sound system.



# Product markings



The crossed-out wheelee bin symbol means that the product, literature and packaging included must be taken to separate collection at the end of their working life. Do not dispose of these products as unsorted municipal waste: take them for recycling. For info on your nearest recycling point, check with your local waste authority.



This product has been granted with the CE certification mark to show that the product follows the health, safety, and environmental protection standards for products sold within the European Economic Area (EEA).



DLS products complies with the relevant provisions of the RoHS Directive for the European Union. In common with all Electrical and Electronic Equipment (EEE) the product should not be disposed of as household waste. Alternative arrangements may apply in other jurisdictions.



DLS is a global partner of the European Mobile Media Association, an organisation that focus on promoting the custom made mobile media installations to consumers.

We follow a policy of continuous advancement in development. For this reason all or part of specifications & designs may be changed without prior notice. We reserve for possible typos, factual or numeric errors that may have been printed on any products, package designs, user manuals and/or other included accessories.







CRUISE