

GROUND ZERO®

GERMAN ENGINEERING

IRIDIUM-SERIES AMPLIFIER

OWNER'S MANUAL

GZIA 1.600HPX-II

GZIA 2080HPX-II

GZIA 2130HPX-II

GZIA 2235HPX-II

GZIA 4115HPX-II

Features

- 4 Ohm / 2 Ohm stable Stereo
- 1 Ohm stable Mono (GZIA 1.600HPX-II)
- Power & Protection indicator
- Bass Boost (1.600HPX-II)
- Variable highpass (GZIA 2080HPX-II / 2235HPX-II / 2130HPX-II / 4115HPX-II)
- Variable lowpass
- Auto-On @ High Level Input
- Adjustable input sensitivity
- Soft delayed remote turn- on
- Bass remote (1.600HPX-II / 2235HPX-II & GZIA 2130HPX-II optional)
- Thermal / Short / Overload protection

Tools and materials you need

- Screwdriver
- Electric drill, 3 mm / 0.12" carbide drill bit
- Mounting screws
- Power wire min. 10 mm² / 7 AWG
- Ground wire min. 10 mm² / 7 AWG
- Speaker wire min. 2 x 1,5 mm² / 15 AWG

Please note!

- As a precaution it is advisable to disconnect the vehicle's battery before making connection to the +12 Volts supply wiring (see owner's manual of your car for further information).
- Please use great caution drilling your trunk. Your gas tank and brake lines can be damaged by puncturing with your drill bit – this could cause damage or failure of your car's operating systems.
- Never pass wires over sharp angles. It is recommended to buffer the power supply of the amplifier with a capacitor min. 1 Farad to guarantee a stable operation voltage.

WARNING !

High powered audio systems in a vehicle are capable of generating "Live Concert" levels of sound pressure. Continued exposure to excessively high volume sound levels may cause hearing loss or damage. Also, operation of a motor vehicle while listening to audio equipment at high volume levels may impair your ability to hear external sounds such as; horns, warning signals, or emergency vehicles, thus constituting a potential traffic hazard. In the interest of safety, Consumer Electronics recommends listening at lower volume levels while driving.

Planning your system

Before beginning the installation, consider the following:

- a. If you plan to expand your system by adding other components sometime in the future, ensure adequate space is left, and cooling requirements are met.
- b. If your radio / source is equipped with pre-amp outputs, it is possible to utilize them to drive the amplifier

Mounting your amplifier

- a. Select a suitable location that is convenient for mounting, is accessible for wiring and has ample room for air circulation and cooling.
- b. Use the amplifier as a template to mark the mounting holes, remove the amplifier.

Warning

Choose a mounting position where all eclectic wires are protected from being damaged by sharp edges, heat or other conditions. +12Volt DC electrical connections must be fused on the battery side. Make sure your radio and all other devices will be turned off while connection your system.

If you need to replace the power fuse, replace it only with a fuse identical to that supplied with the system. Using a fuse of different type or rating may result in damage to this system which isn't covered by the warranty.

Controls and functions – GZIA 1.600HPX-II

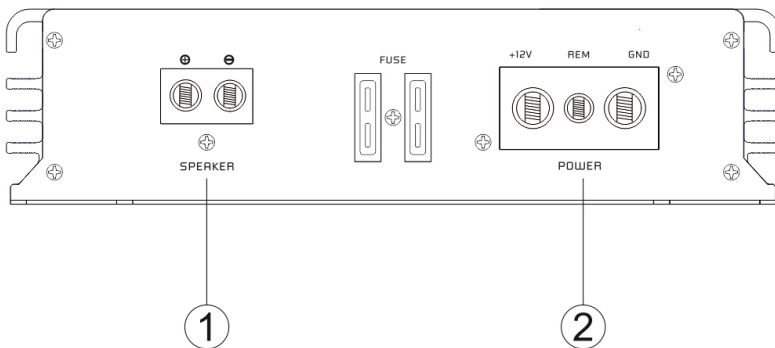
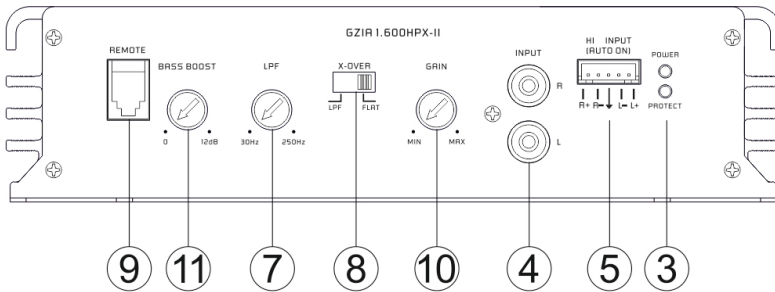

Controls and functions – GZIA 2080HPX-II

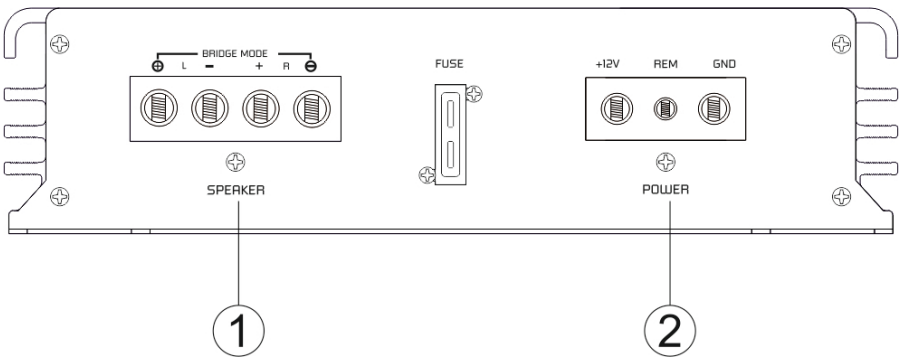
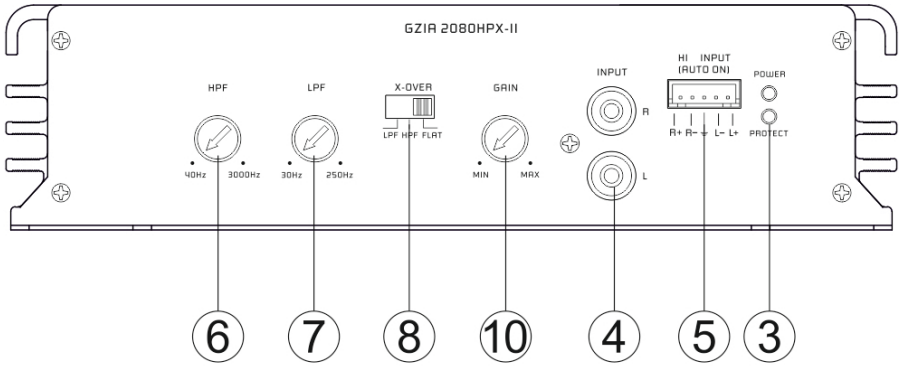

Controls and functions – GZIA 2130HPX-II

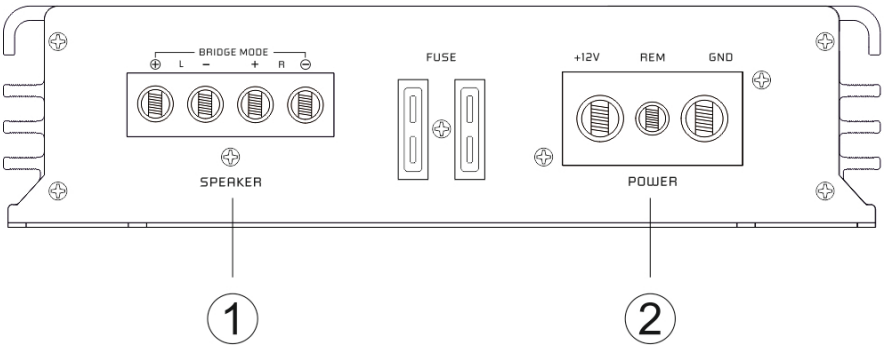
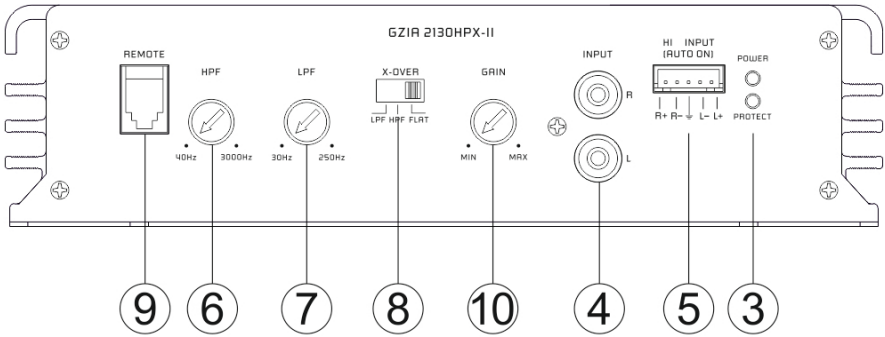

Controls and functions – GZIA 2235HPX-II

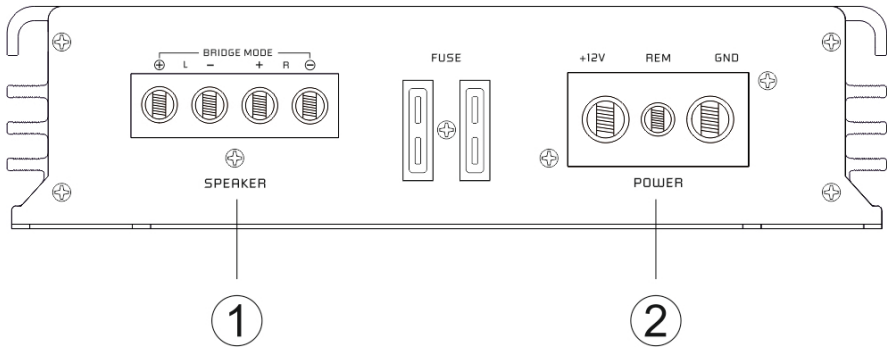
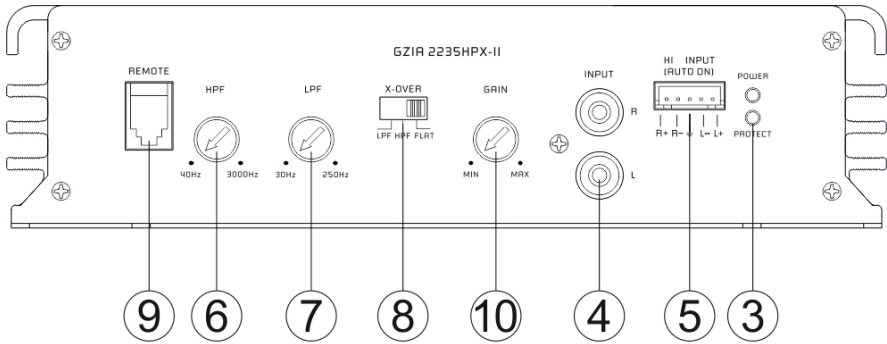

Controls and functions – GZIA 4115HPX-II

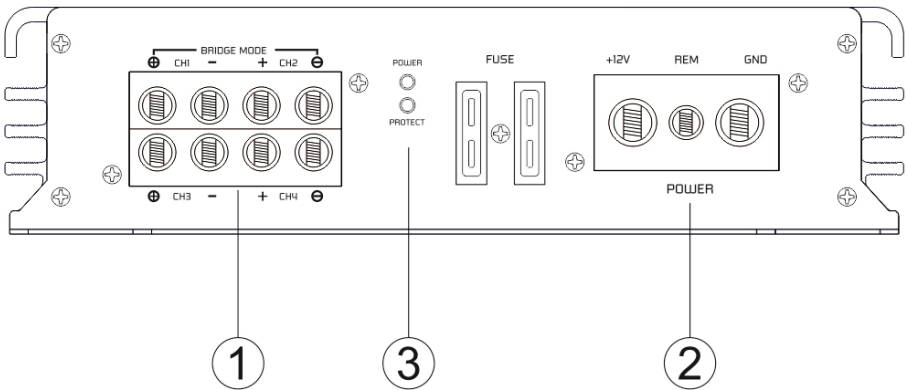
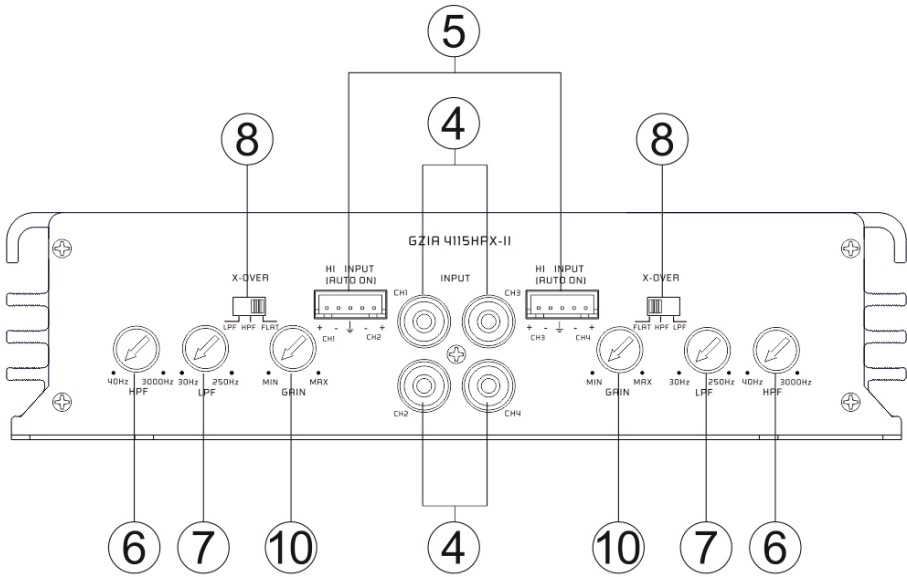

Controls and functions

1	Speaker terminals	For connection of the speakers GND -> Ground connection
2	Power terminals	REM -> Remote antenna terminal [Not for use with High level inputs (5)] BATT -> +12 Volt
3	Status indication	GREEN – OK RED – Error
4	Cinch inputs	Terminal for connection of the RCA wires. To avoid failure, please use high quality RCA wires. IMPORTANT! Do not use the High level inputs and the Cinch inputs parallel, this can damage the amplifier. Use either the Cinch OR the High Level inputs.
5	High Level inputs	These inputs must be used if your head unit is not equipped with a Low Level Cinch output. Connect this input to the speaker outputs of your head unit. The amplifier automatically turns on as soon as a signal is received (Auto On). The remote connection of the Power- Terminal (2) won't be used. IMPORTANT! Do not use the High level inputs and the Cinch inputs parallel, this can damage the amplifier. Use either the Cinch OR the High Level inputs.
6	High Pass controller	Set the filter switch to „HIGH“ position. Adjust the variable HPF crossover frequency to the desired frequency using the controller. All frequency between 40 and 3000 Hz will be reproduced.
7	Low Pass controller	Only frequencies from 30Hz to 250Hz will be reproduced (depending on the LPF filter controller position). Set the filter switch to „LOW“ position. Adjust the variable LPF frequency to the desired frequency using the controller.
8	Mode switch	Adjust the crossover for the chosen utilization. LPF – Only bass frequencies (below 30Hz - 250Hz) will be reproduced. FLAT – All frequencies will be reproduced. HPF – Only middle and high frequencies (over 40Hz – 3000Hz) will be reproduced.
9	Remote control input	For connection of bass remote control (GZIA 2130HPX-II & 2235HPX-II optional/1.600HPX-II)
10	Input level controller	With this controller you can adjust the input sensitivity.
11	Bass Boost controller	For adjusting a Bass Boost at 45 Hz from 0 – 12 dB

High Level Input

Depending on the configuration of your car and sound system, error noises may appear when using the high level inputs. Please use the additional middle ground-connection of this input to reduce these noises.

The Auto-On function allows you to use the amplifier without an additional remote connection. This makes it possible to operate it with an OEM headunit and OEM active systems, which are not equipped with cinch outputs or switched remote-outputs.

High Level Input – GZIA 1.600HPX-II

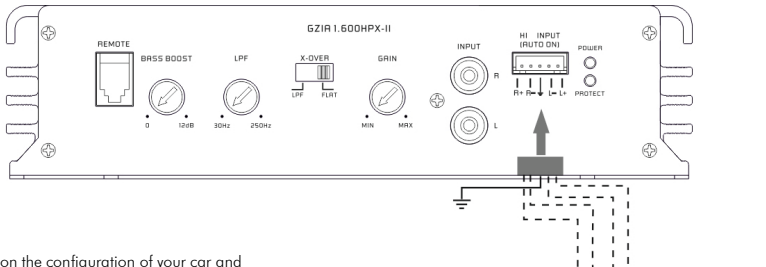

Depending on the configuration of your car and sound system, error noises may appear when using the high level inputs.

Please use the additional middle ground-connection of this input to reduce these noises.

Connect this wire to the GND powerterminal.

A connection to the GND connection of the signal source can also be useful.

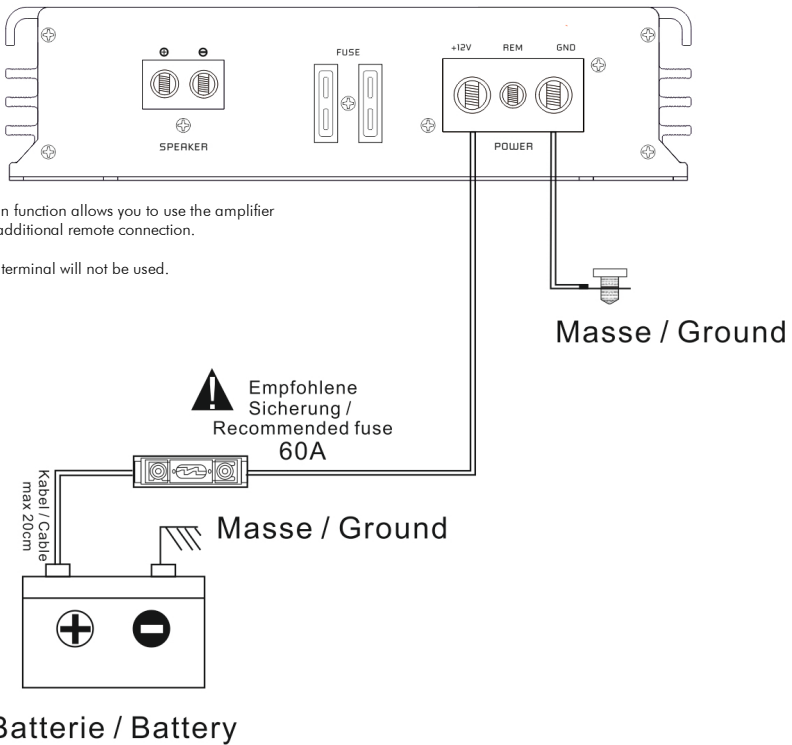

High Level Input – GZIA 2080HPX-II

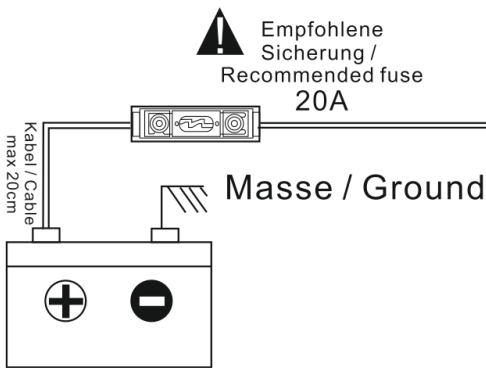
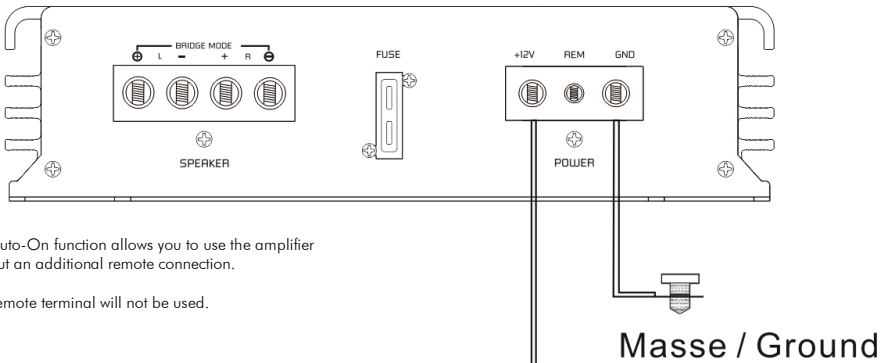
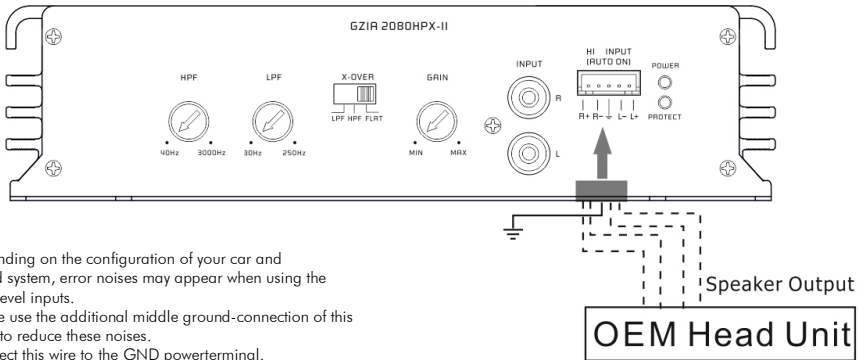

High Level Input – GZIA 2130HPX-II

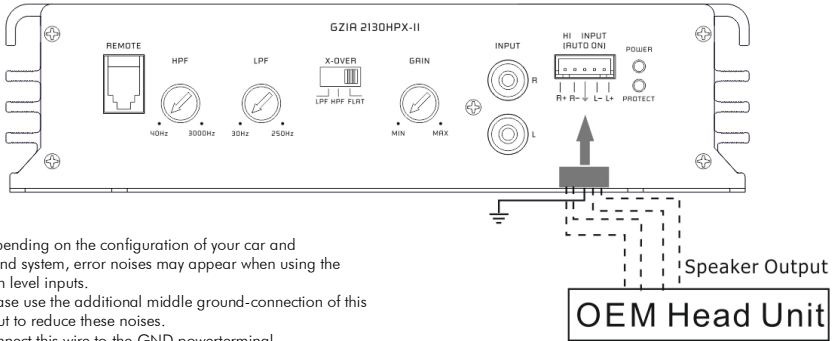

Depending on the configuration of your car and sound system, error noises may appear when using the high level inputs. Please use the additional middle ground-connection of this input to reduce these noises. Connect this wire to the GND powerterminal. A connection to the GND connection of the signal source can also be useful.

The Auto-On function allows you to use the amplifier without an additional remote connection. The remote terminal will not be used.

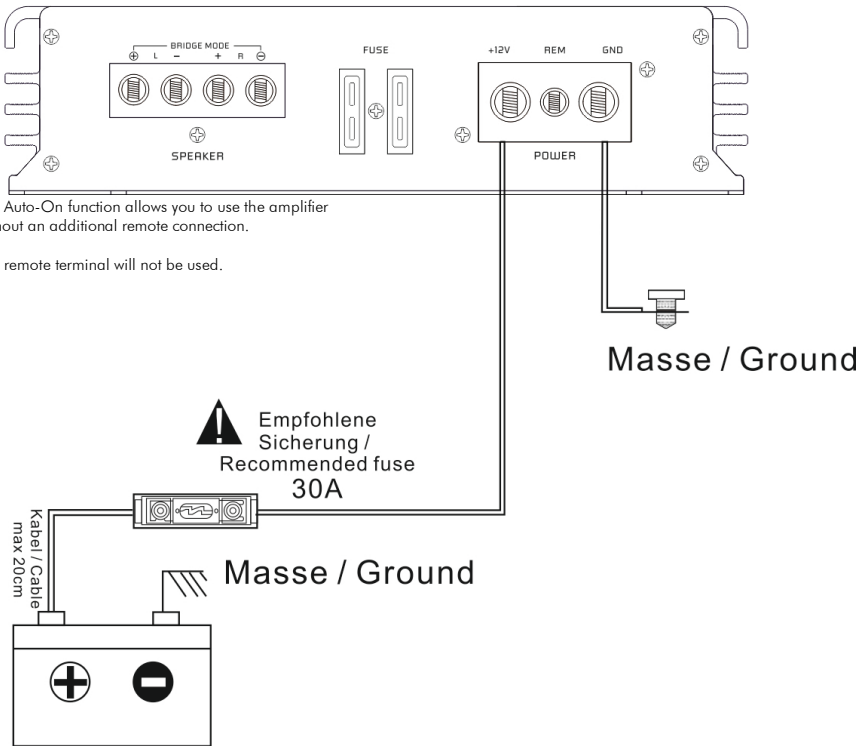

Batterie / Battery

High Level Input – GZIA 2235HPX-II

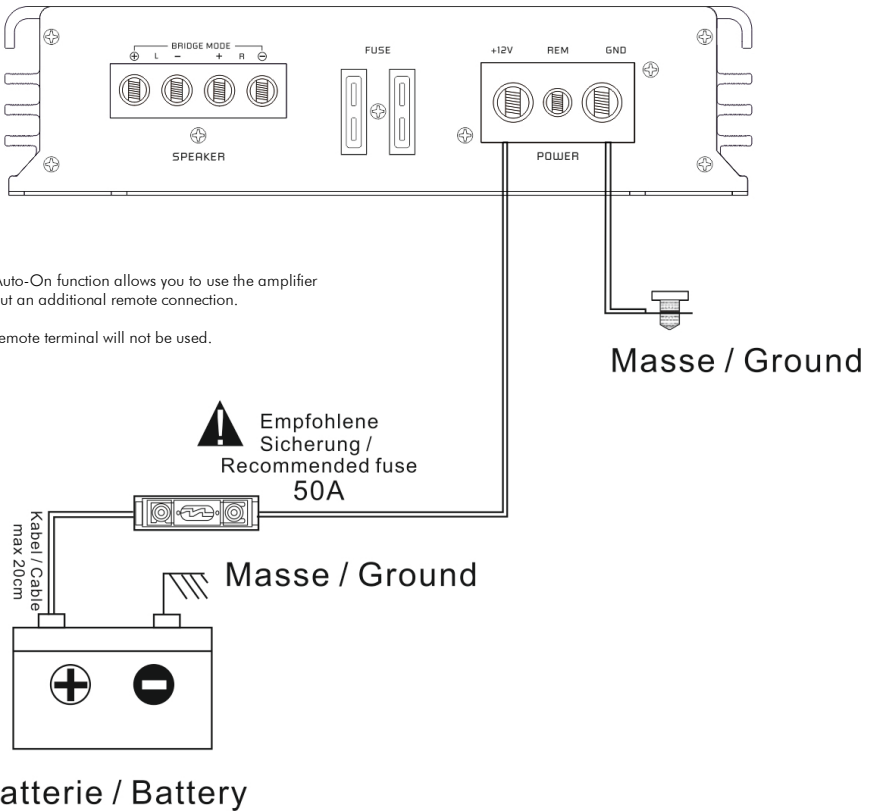
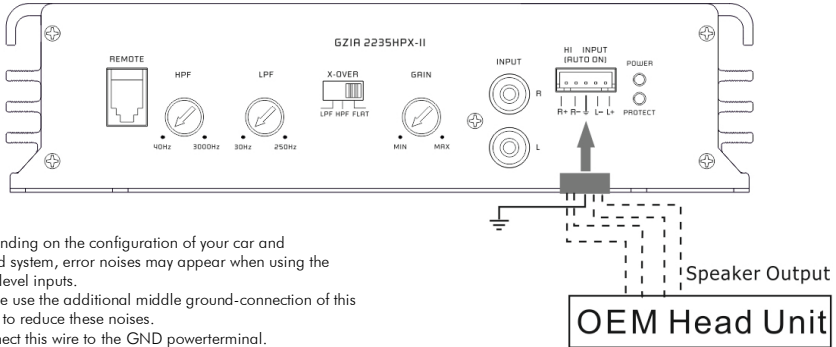

High Level Input – GZ1A 4115HPX-II

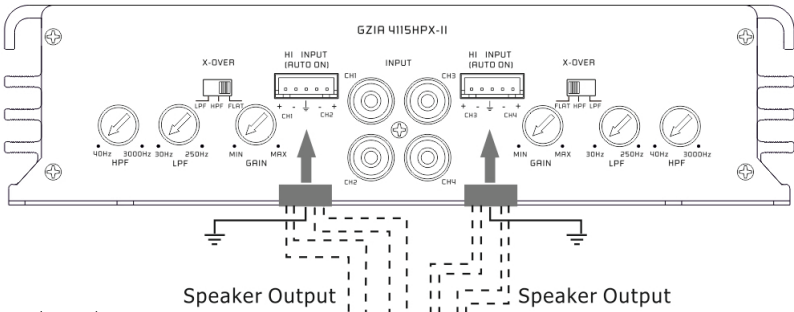

Depending on the configuration of your car and sound system, error noises may appear when using the high level inputs. Please use the additional middle ground-connection of this input to reduce these noises. Connect this wire to the GND powerterminal. A connection to the GND connection of the signal source can also be useful.

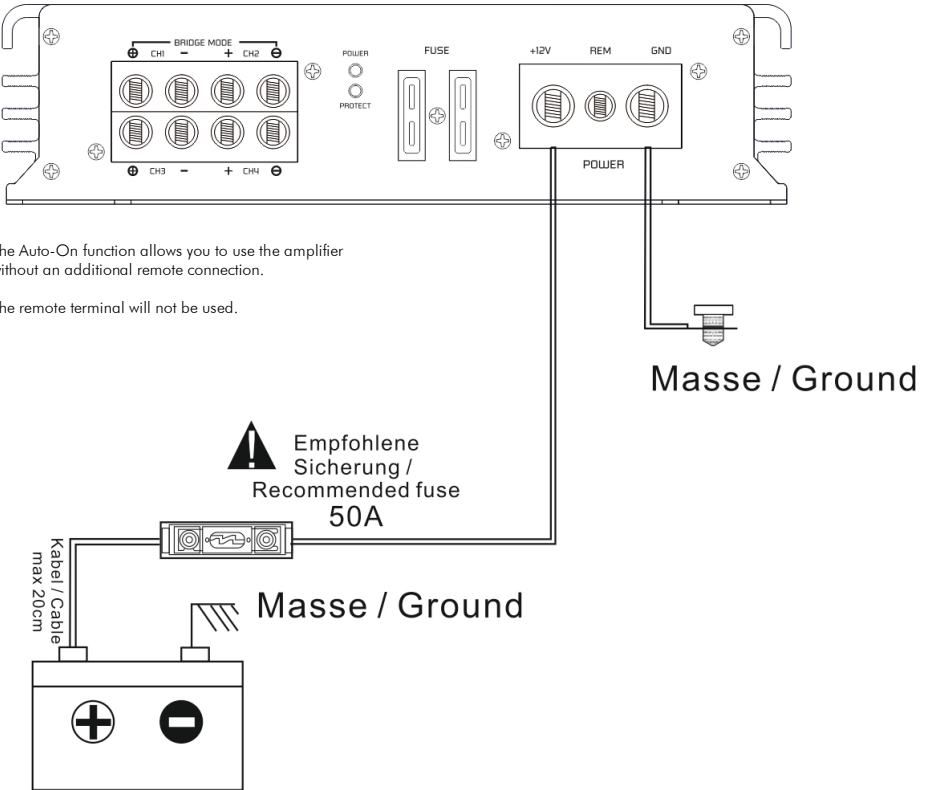

Batterie / Battery

Turning on the amplifier

The amplifier automatically turns on a few seconds after you turn on your radio.

Note: Your amplifier temporarily shuts down if it gets too hot, then restarts automatically once it cools

(At about 80° / 176° F).

Adjusting the audio level

1. LEVEL (Min/Max): Turn fully counter-clockwise to MIN position
2. Turn the auto sound system's volume control to about two-third of its full range.
3. Adjust LEVEL to a comfortable listening level.

Connecting the speaker for trimode operation - notes

TRI MODE operation output allows a subwoofer to be operated in mono mode while the main speakers are playing in stereo. Leave the crossover switch on "Full" position.

Use 100 volt, non-polar capacitors for a high pass crossover to filter out low frequencies and Air-core or Ferrit-ore coils with a minimum diameter of 1 mm / 0.039" for the lowpass crossover to filter out high frequencies.

The capacitor and inductor values as written in the below table. The front and rear channels of this amplifier get this capability. Only the rear left and right channels are shown on the following pictures.

Values for 6dB passive crossover

Frequency	Inductor	Capacitor
80 Hz	7,5 mH	470 uF
100 Hz	6,5 mH	330 uF
120 Hz	5,5 mH	370 uF
150 Hz	4 mH	220 uF

Wiring – GZIR 1.600HPX-II

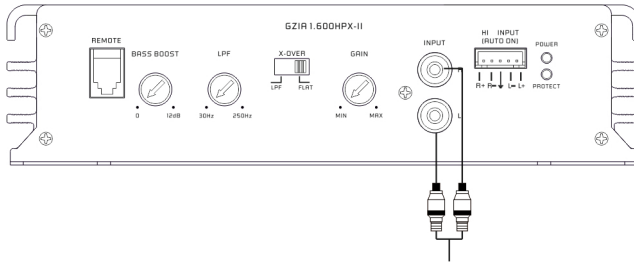

Zum Line out des Autoradios /
To car stereo line out /
Sortie stéréo de la voiture /
Naar line out radio

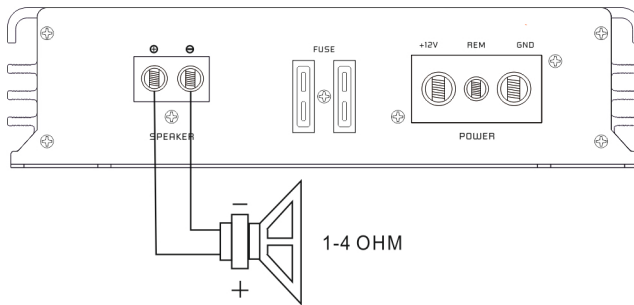

**Lautsprecher Impedanz /
Speaker impedance / Impédance haut parleur
1 ~ 4 Ohm**

Stereo wiring – GZIA 2080HPX-II

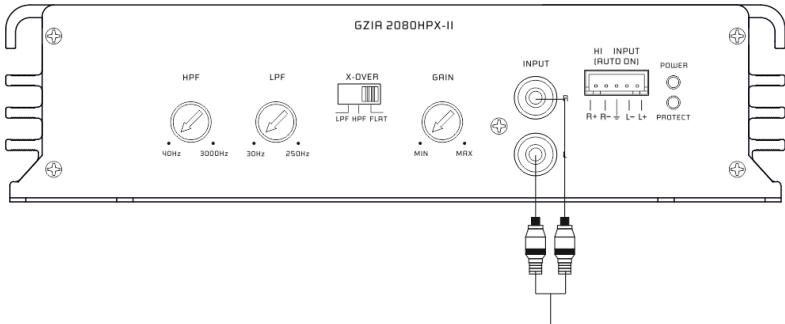

Zum Line out des Autoradios /
 To car stereo line out /
 Sortie stéréo de la voiture /
 Naar line out radio

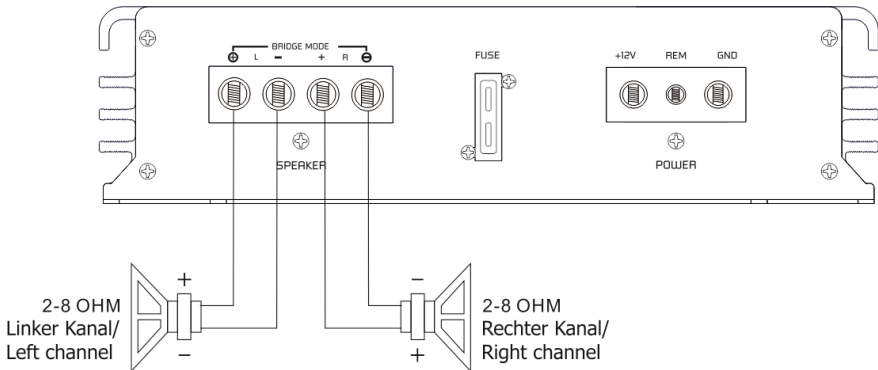

Speaker impedance 2~8 Ohm

Mono wiring – GZIA 2080HPX-II

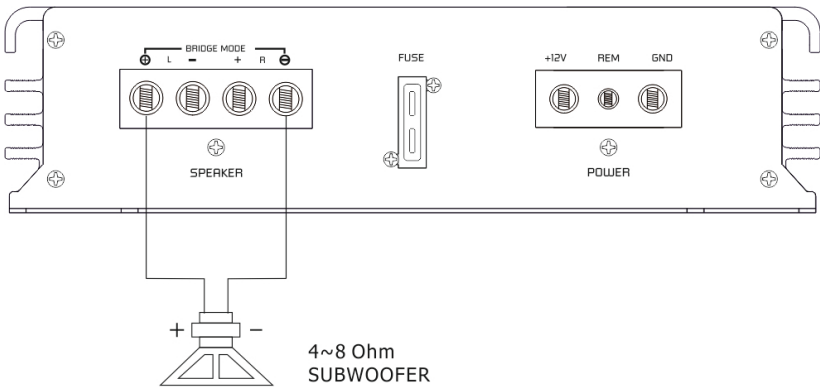

Speaker impedance 4~8 Ohm

Trimode wiring – GZIA 2080HPX-II

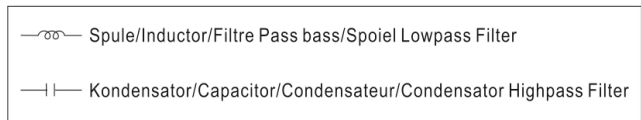
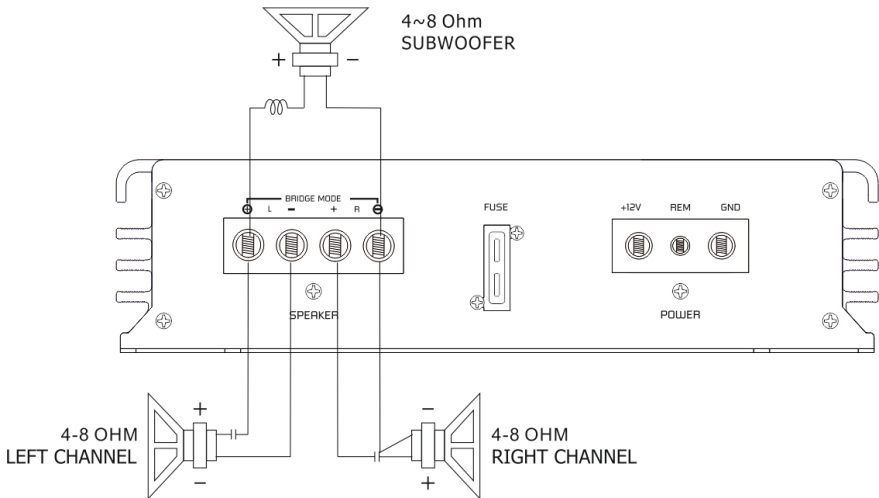

Speaker impedance 4~8 Ohm

Stereo wiring – GZIA 2130HPX-II

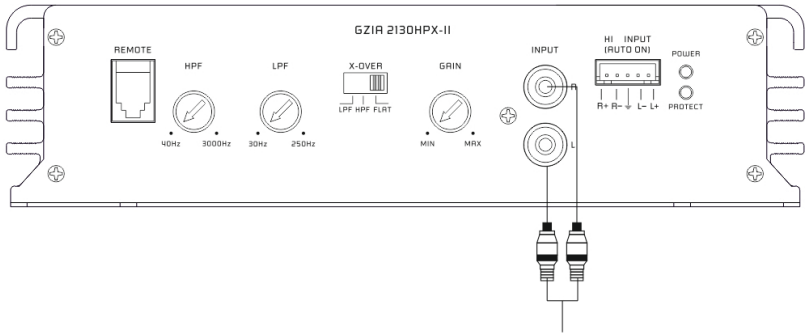

Zum Line out des Autoradios /
To car stereo line out /
Sortie stéréo de la voiture /
Naar line out radio

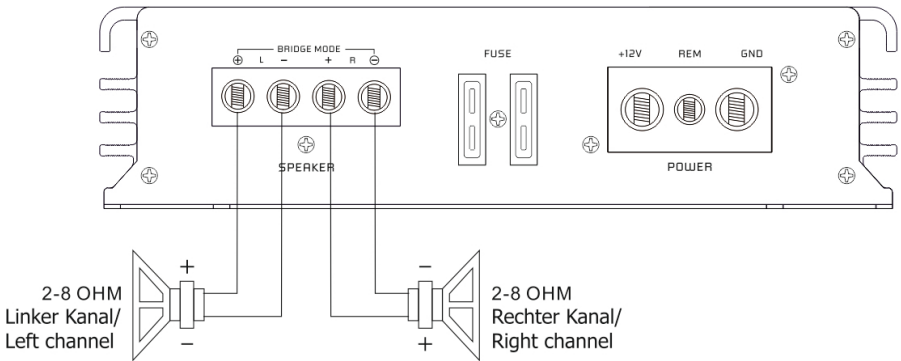

Speaker impedance 2~8 Ohm

Mono wiring – GZIA 2130HPX-II

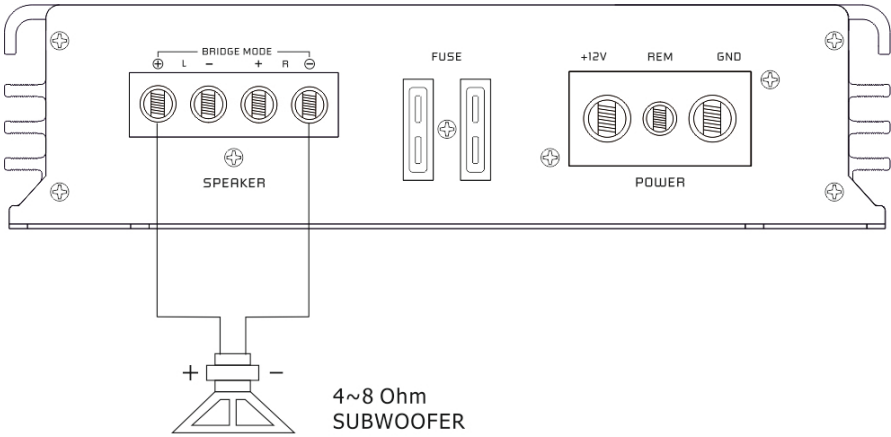

Speaker impedance 4~8 Ohm

Trimode wiring – GZIA 2130HPX-II

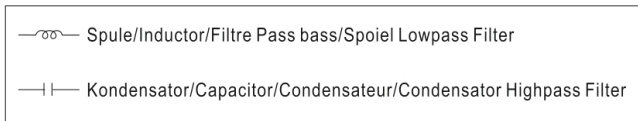
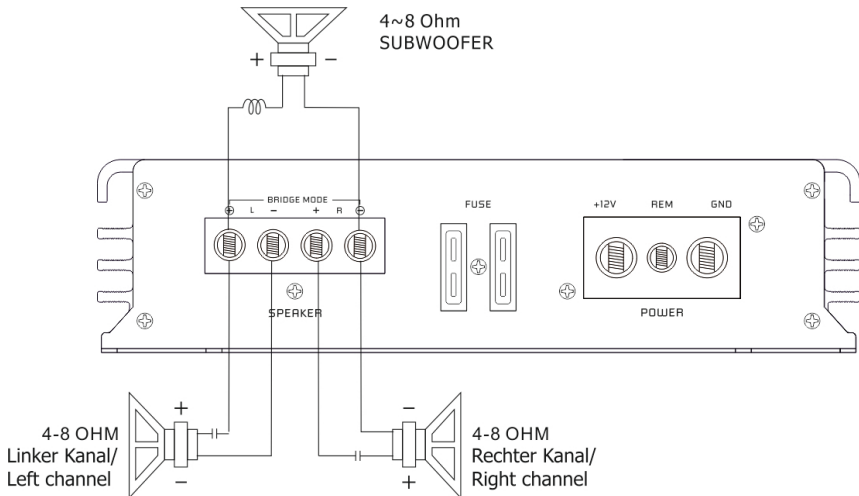

Speaker impedance 4~8 Ohm

Stereo wiring – GZIA 2235HPX-II

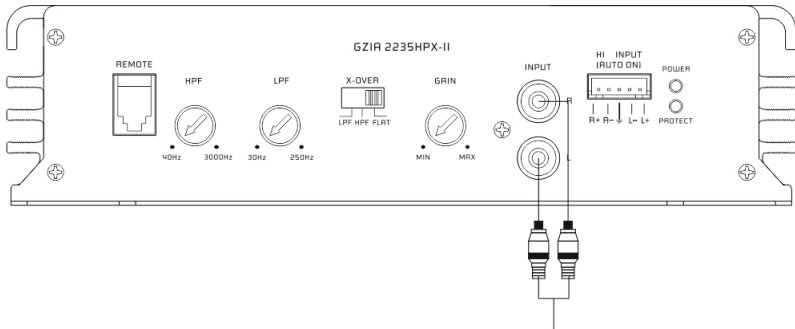

Zum Line out des Autoradios /
 To car stereo line out /
 Sortie stéréo de la voiture /
 Naar line out radio

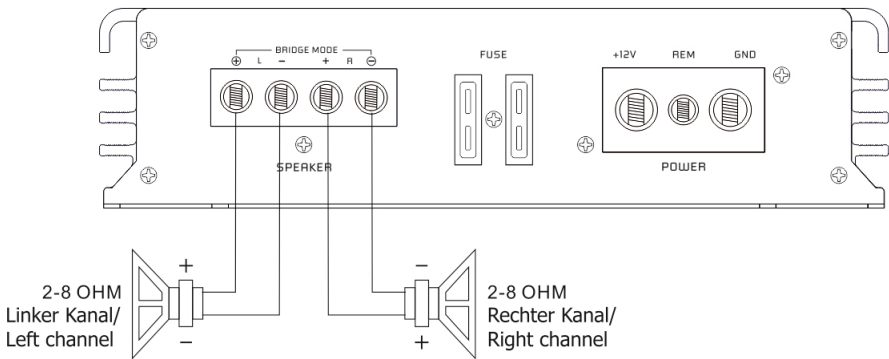

Speaker impedance 2~8 Ohm

Mono wiring – GZIA 2235HPX-II

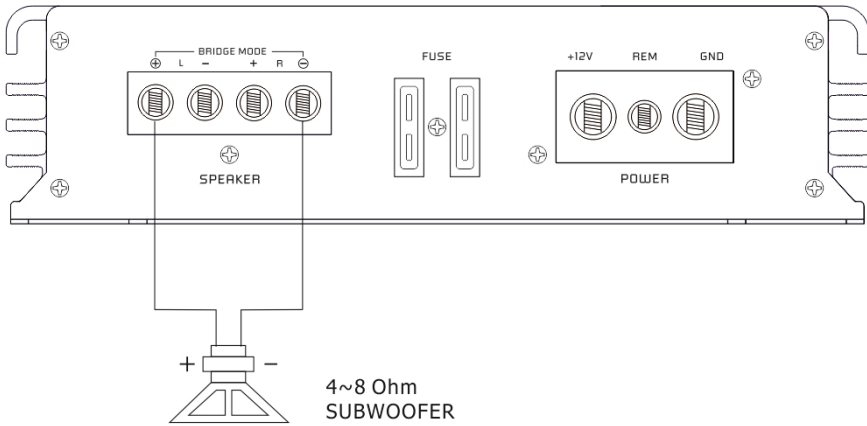

Speaker impedance 4~8 Ohm

Trimode operation – GZIA 2235HPX-II

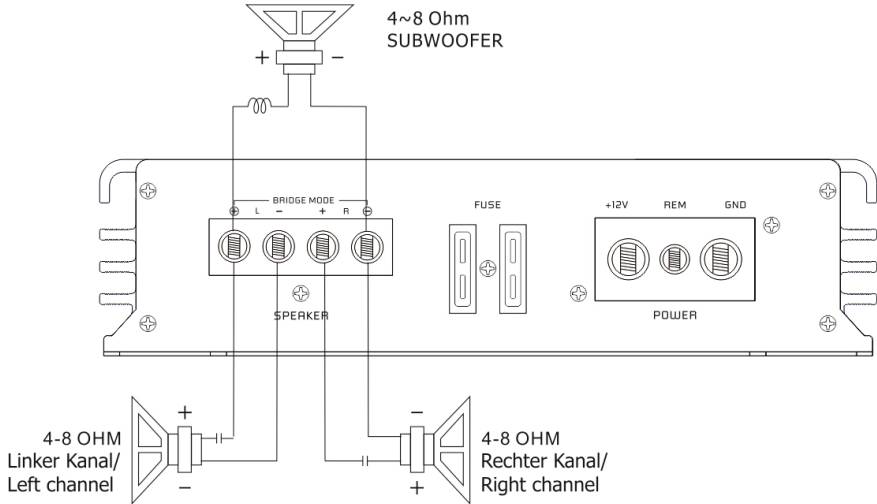

—○— Spule/Inductor/Filtre Pass bass/Spoiel Lowpass Filter

—|— Kondensator/Capacitor/Condensateur/Condensator Highpass Filter

Speaker impedance 4~8 Ohm

Stereo wiring – GZIA 4115HPX-II

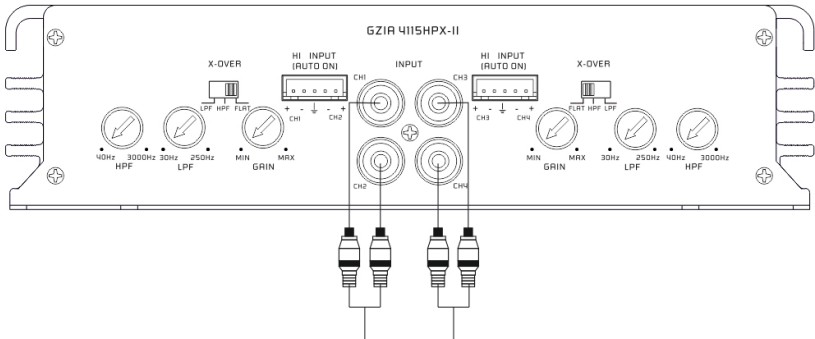

Zum Line out des Autoradios /
To car stereo line out /
Sortie stéréo de la voiture /
Naar line out radio

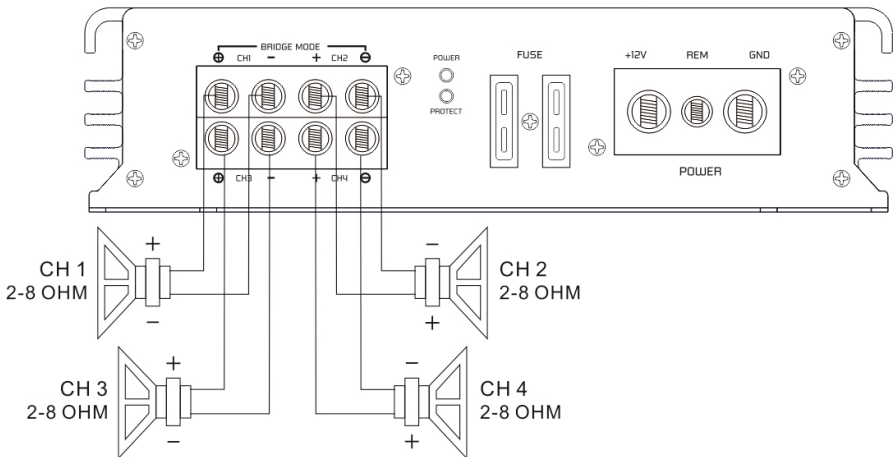

Speaker impedance 2~8 Ohm

Bridged wiring – GZIA 4115HPX-II

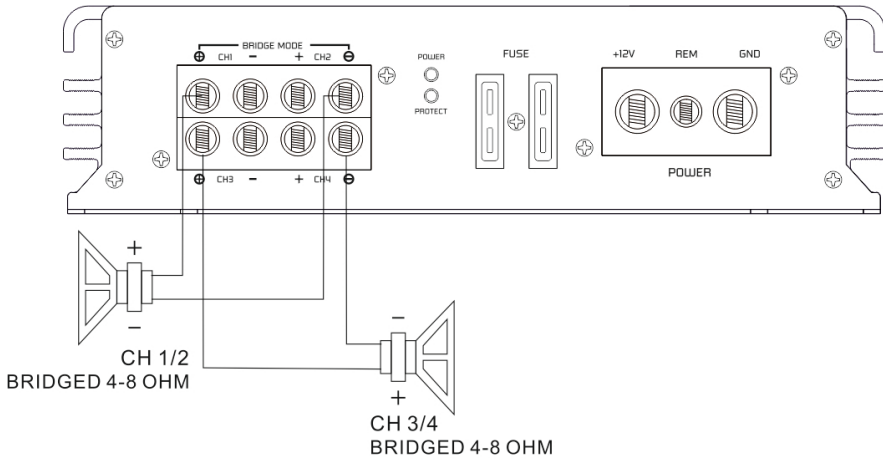

Speaker impedance 4~8 Ohm

Trimode operation – GZIA 4115HPX-II

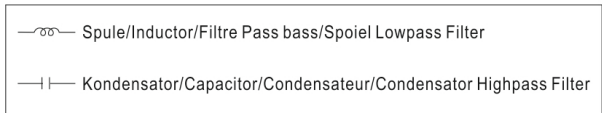
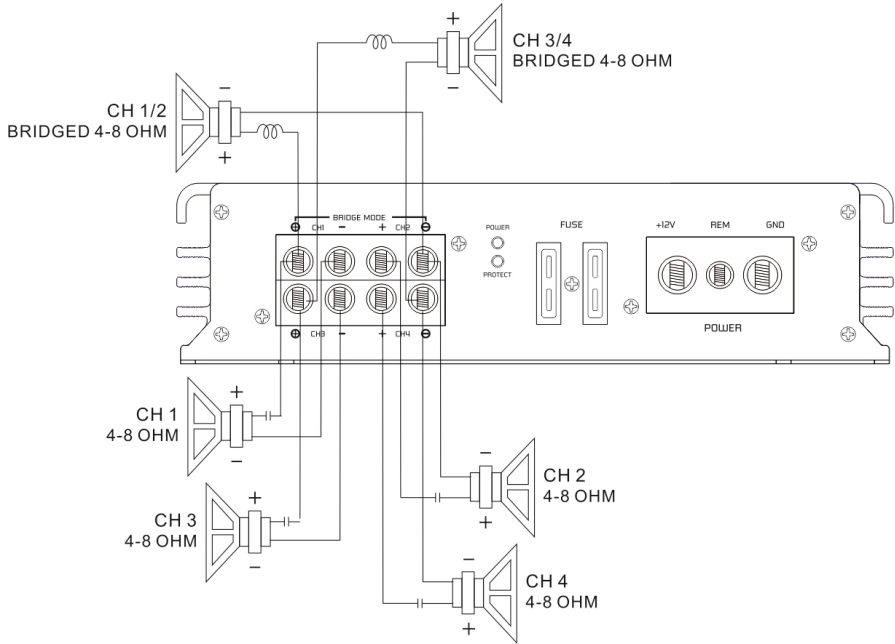

Speaker impedance 4~8 Ohm

Specifications

Model	GZIA 1.600HPX-II
Type	1 Channel Class A/B
RMS Power @ 4 Ω CEA Standard CEA-2006-A	1 x 230 W (1% THD+N)
RMS Power @ 2 Ω CEA Standard CEA-2006-A	1 x 400 W (1% THD+N)
RMS Power @ 1 Ω CEA Standard CEA-2006-A	1 x 600 W (1% THD+N)
MAX Power CEA Standard CEA-2006-A	1 x 700 W @ 1 Ω (10% THD+N)
Damping factor	> 150
Signal to noise Ratio	> 80 dB
Lowpass	30 – 250 Hz
Bass Boost	0 – 12 dB
Highpass	-
Frequency response	10 Hz – 30 KHz
Input sensitivity	200 mV – 6 V
Bass remote control	✓
Auto-On @ High Input	✓
Fuse	2 x 30A
Dimensions / heatsink only W x H x L (mm)	192 x 49 x 332
Dimensions / overall W x H x L (mm)	192 x 49 x 360
Dimensions / heatsink only W x H x L (inch)	7,56 x 1,93 x 13,07
Dimensions / overall W x H x L (inch)	7,56 x 1,93 x 14,17

Specifications

Model	GZIA 2080HPX-II	GZIA 2130HPX-II	GZIA 2235HPX-II	GZIA 4115HPX-II
Type	2 Channel Class A/B	2 Channel Class A/B	2 Channel Class A/B	4 Channel Class A/B
RMS Power @ 4 Ω CEA Standard CEA-2006-A	2 x 60 W (1% THD+N)	2 x 85 W (1% THD+N)	2 x 150 W (1% THD+N)	4 x 70 W (1% THD+N)
RMS Power @ 2 Ω CEA Standard CEA-2006-A	2 x 80 W (1% THD+N)	2 x 130 W (1% THD+N)	2 x 235 W (1% THD+N)	4 x 115 W (1% THD+N)
RMS Power @ 1 Ω CEA Standard CEA-2006-A	-	-	-	-
RMS Power @ 4 Ω Bridged CEA Standard CEA-2006-A	1 x 200 W (1% THD+N) 1 x 240 W (10% THD+N)	1 x 260 W (1% THD+N) 1 x 320 W (10% THD+N)	1 x 470 W (1% THD+N) 1 x 540 W (10% THD+N)	2 x 230 W (1% THD+N) 2 x 250 W (10% THD+N)
Damping factor	> 150	> 150	> 100	> 100
Signal to noise Ratio	> 85 dB	> 85 dB	> 80 dB	> 80 dB
Lowpass	30 – 250 Hz	30 – 250 Hz	30 – 250 Hz	30 – 250 Hz
Highpass	40 – 3000 Hz	40 – 3000 Hz	40 – 3000 Hz	40 – 3000 Hz
Frequency response	10 Hz – 30 KHz	10 Hz – 30 KHz	10 Hz – 30 KHz	10 Hz – 30 KHz
Input sensitivity	200 mV – 6 V	200 mV – 6 V	200 mV – 6 V	200 mV – 6 V
Bass remote control	-	✓ (optional)	✓ (optional)	-
Auto-On @ High Input	✓	✓	✓	✓
Fuse	1 x 20A	2 x 15A	2 x 25A	2 x 25A
Dimensions / heatsink only W x H x L (mm)	192 x 49 x 174	192 x 49 x 214	192 x 49 x 284	192 x 49 x 284
Dimensions / overall W x H x L (mm)	192 x 49 x 202	192 x 49 x 242	192 x 49 x 312	192 x 49 x 312
Dimensions / heatsink only W x H x L (inch)	7,56 x 1,93 x 6,85	7,56 x 1,93 x 8,43	7,56 x 1,93 x 11,18	7,56 x 1,93 x 11,18
Dimensions / overall W x H x L (inch)	7,56 x 1,93 x 7,95	7,56 x 1,93 x 9,53	7,56 x 1,93 x 12,28	7,56 x 1,93 x 12,28

Trouble shooting guide

Symptoms	Check Points	Cure
No sound	Is the POWER LED illuminated?	Check fuses in amplifier. Be sure remote lead is connected. Check signal leads. Check again control. Check tuner/deck volume level.
	Is the diagnostic LED illuminated?	Check for speaker short or amplifier overheating
Amp not switching on	No power to the amplifier	Check power wire or connections
	No power to remote wire with receiver on	Check connections to radio
No sound in one channel	Check speaker leads	Inspect for short circuit or an open connection
	Check audio leads	Reverse left and right RCA inputs to determine if it is occurring before the amp
Amp turning off at medium / high volume	Check speaker load impedance	Be sure proper speaker load impedance recommendations are observed (If you use an ohm meter to check speaker resistance, please remember that DC resistance and AC impedance may not be the same.)
Protection LED is on	Temperature shut down	Turn radio volume down
	Speaker wires short	Separate speaker wires and insulate

Die Gewährleistung entspricht der gesetzlichen Regelung. Eine Rücksendung kann nur nach vorheriger Absprache und in der Originalverpackung erfolgen. Bitte unbedingt einen maschinell erstellten Kaufbeleg und eine Fehlerbeschreibung beilegen. Von der Gewährleistung ausgeschlossen sind Defekte, die durch Überlastung, unsachgemäße Behandlung oder bei Teilnahme an Wettbewerben entstanden sind. Wir behalten uns das Recht vor, zukünftig nötige Änderungen oder Verbesserungen an dem Produkt vorzunehmen ohne den Kunden darüber zu informieren.

Limited warranty - defective products must be returned in original packaging - please add a copy of the original purchasing invoice showing the purchasing date and a detailed description of the failure. Failure caused by overload, misuse or by using the product for competition purpose are not covered by the warranty. We reserve the right to make needed change or improvement to the product without informing customer about this in advance.

De Garantie bepalingen van alle door ground zero geleverde producten is volgens wettelijke bepalingen geregeld. Een retourzending kan alleen na duidelijke afspraak en in de originele verpakking plaatsvinden. SVP een aankoopbon en een duidelijke storingsomschrijving bijvoegen. Van garantie uitgesloten zijn defecten door overbelasting, onkundig gebruik, of door deelname aan wedstrijden (SPL) ontstaan zijn. Wij behouden ons het recht om de nodige veranderingen of verbeteringen aan het product door te voeren zonder de klant hierover te informeren.

La garantie est conforme aux droits légaux. Un retour du produit défectueux doit être dans son emballage d'origine sur présentation du reçu ou de la facture indiquant la description du défaut. La présente Garantie n'est pas applicable lorsque le produit a été endommagé en raison: Mauvaise alimentation, Trop de puissance (HP, Subwoofer) Accident, Installation ou Utilisation non conforme aux normes Technique (Concours SPL etc). Nous nous réservons le droit d'entreprendre à l'avenir nécessairement des modifications ou des améliorations au produit sans informer le client.

Ground Zero GmbH

Erlenweg 25, 85658 Egming, Germany

Tel. +49 (0)8095/873 830 Fax -8310

www.ground-zero-audio.com

